

Delivering leading edge, innovative power solutions for more than **30** years....

Model:GTM86100-10VV-W2H-USB

May 20, 2022

GTM86100-10VV-W2H-USB

Information

Model Number	GTM86100-10VV-W2H-USB
Description	GTM86100-10VV-W2H-USB, ICT / ITE / Medical Power Supply, Wall Plug-in, AC/DC Switching Adapter with USB Power Supply AC Adaptor, , Input Rating: 100-240V~, 50-60Hz, The Indian uses 230 Volts, 50 Hz alternating current as the power source, Output Rating: 10 Watts, Power rating with convection cooling (W) , 5-5.2V in 0.1V increments, Approvals: CB 60335; CE; RoHS; China RoHS; Double Insulation; Level VI; VCCI; WEEE; EAC; CB 62368; cETLus 62368-1; CB 60601-1;
Model Picture	.
Agency Documents	http://www.globtek.info/certs/GTM86100/
CE EC-Declaration	https://www.globtek.com/pdf/ec_declaration/a000c00000PH1q4EAD
RoHS/RoHS2 Declaration	https://www.globtek.com/pdf/rohs_cert/a000c00000PH1q4EAD
REACH Declaration	https://www.globtek.com/pdf/iso_certificates/REACH.pdf
Conflict Minerals Declaration	https://www.globtek.com/pdf/conflict-minerals.pdf

Delivering leading edge, innovative power solutions for more than **30** years....

Model:GTM86100-10VV-W2H-USB

May 20, 2022

MODEL PARAMETERS

Type	Wall Plug-in
Technology	AC/DC Switching Adapter with USB Power Supply AC Adaptor
Category	ICT / ITE / Medical Power Supply
Input Voltage	100-240V~, 50-60Hz
I/P Amps (A)	0.3A
Wattage (W)	10.0
Vout Range (V)	5-5.2
Efficiency Level	USA DOE Level VI / Eco-design Directive 2009/125/EC, (EU) 2019/1782
Ingress Protection	
Size (mm)	55.8*24.0*42.2 +/-1

Delivering leading edge, innovative power solutions for more than 30 years....

Model:GTM86100-10VV-W2H-USB

May 20, 2022

ENCLOSURE

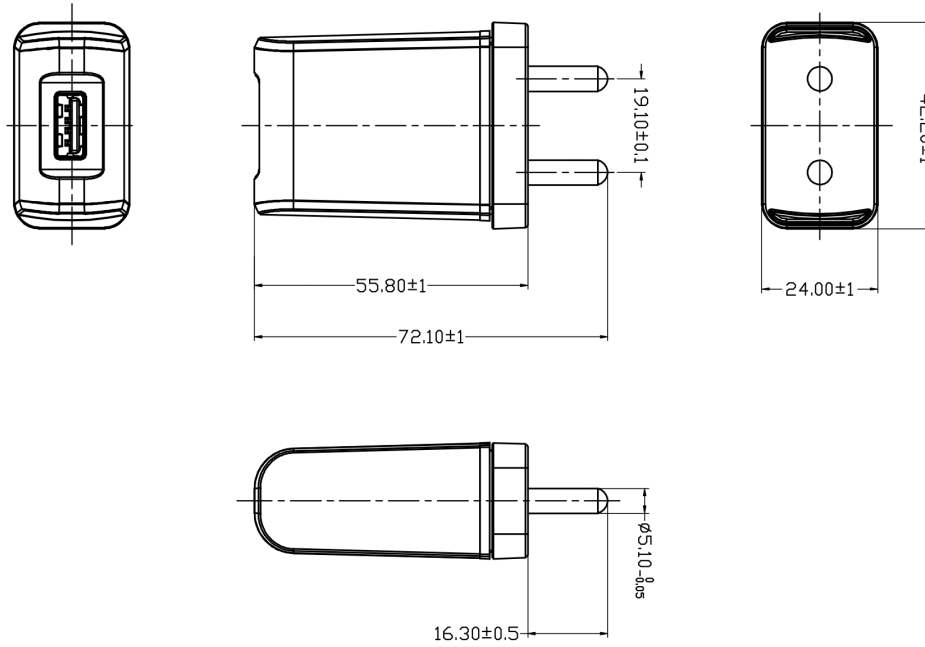

Delivering leading edge, innovative power solutions for more than **30** years....

Model:GTM86100-10VV-W2H-USB

May 20, 2022

RATING TABLE

Model Number	Voltage	Amps(A)	Watts(W)	RFQ
GTM86100-1005-W2I-USB	5 V	2	10.00	RFQ

Model:GTM86100-10VV-W2H-USB

May 20, 2022

SPECIFICATIONS

01. Input Voltage: Specified 90-264 Vac, Nameplate rated: 100-240Vac
02. Input Frequency: Specified 47-63 Hz, Nameplate rated 50/60Hz
03. Output Regulation: +/- 5% measured at the end of a 1 meter USB cordset employing #20 Gauge conductors
04. Line Voltage Regulation: +/- 1% typical measured at the end of a 1 meter USB cordset employing #20 Gauge conductors
05. Output Ripple (Vp-p): 1% or 100 mV whichever is greater, measured at 20 MHz bandwidth with 0.1 uf ceramic capacitor in parallel with a low impedance 47 uf electrolytic capacitor connected at the end of the output connector
06. Hold-up Time: 5 mS minimum
07. Inrush Current: 30A maximum @ 230Vac input
08. Energy Efficiency: Complies to Efficiency Level VI and ErP European Commission's Ecodesign Directive (2005/32/EC) / CoC Tier 2 Compliant

B) PROTECTION

01. Over-current protection: 110%-140% maximum with auto-recovery function
02. Output Over-Voltage: 110% to 130% of nominal output voltage
03. Short-circuit protection: The adapter shall not be damaged by short the DC output to Ground.

C) SAFETY

01. Dielectric Withstand Voltage: Primary To Secondary: 4000VAC or 5656VDC for 3 seconds
02. Leakage Current: 50uA maximum, at nominal 240Vac input voltage
03. ESD Immunity per EN61000-4-2, ±8 kV contact, ±15 kV air, Perf Criteria A Standard.

D) EMC

01. Emissions, per EN 55032, EN 61000-6-3, EN 61000-6-4
 - Conducted Emissions: Class B, FCC Part 15, Class B
 - Radiated Emissions: Class B, FCC Part 15, Class B
02. Line Frequency Harmonics EN61000-3-2, Class A
03. Voltage Fluctuations/Flicker EN61000-3-3
04. Immunity, per EN 55024, EN 61000-6-1, EN 61000-6-2
 - Static Discharge Immunity EN61000-4-2, 8kV Contact Discharge, 15kV air discharge
 - Radiated RF Immunity EN61000-4-3, 3V/m 80-2700MHz, 80% 1KHz AM.
 - EFT/Burst Immunity EN61000-4-4, 2kV/100kHz.
 - Line Surge Immunity EN61000-4-5, 1kV differential, 2kV common-mode
 - Conducted RF Immunity EN61000-4-6, 3Vrms, 80% 1KHz AM
 - Power Frequency Magnetic Field Immunity EN61000-4-8, NA
 - Voltage Dip Immunity EN61000-4-11, Criteria

E) OTHER:

01. MTBF: 300,000 Hours @ 25°C ambient temperature
02. Operating Temperature: 0°C to 50°C ambient temperature
03. Operating Humidity: 20 ~ 85 % RH. non-condensing
05. Storage Temperature: -20°C to 60°C
06. Storage Humidity: 5 ~ 95 % RH. non-condensing
07. Cooling: Natural convection cooling
08. RoHS 2: Complies with EU 2011/65/EU China SJ/T 11364-2014

PROPRIETARY INFORMATION

PROPRIETARY OF GLOBTEK, INC. ANY REPRODUCTION, DISCLOSURE OR USE OF THIS DRAWING, IN WHOLE OR IN PART, IS HEREBY PROHIBITED EXCEPT AS SPECIFIED IN WRITING BY GLOBTEK, INC.

<https://www.globtek.com/datasheet/w70329>

Delivering leading edge, innovative power solutions for more than **30** years....

Model:GTM86100-10VV-W2H-USB

May 20, 2022

F) ENCLOSURE

01. Housing: High impact plastic, 94V0 polycarbonate, non-vented
02. Markings: Label and/or Pad Printed and/or Molded in the case

F) OPTIONS:

01. Green Power On Indicator LED
 02. NEMA 1-15P or European Schuko 7-16 AC Plug Configuration
 03. Increased DC Output Voltage (up to 5.4V) to allow for long output cables
 04. Special International Safety Approvals
 05. Housing Color, special markings
-

Delivering leading edge, innovative power solutions for more than 30 years....

Model:GTM86100-10VV-W2H-USB

May 20, 2022

DERATING CURVE

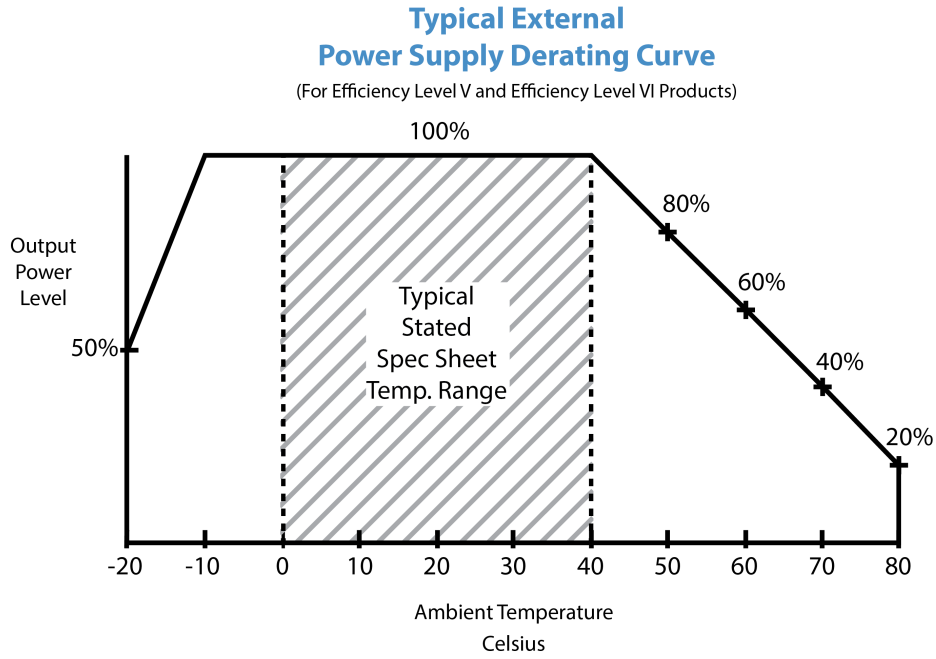

Delivering leading edge, innovative power solutions for more than **30** years....

Model:GTM86100-10VV-W2H-USB

May 20, 2022

INPUT CONFIGURATION

Description The Indian uses 230 Volts, 50 Hz alternating current as the power source

- Class II plugs are rated at 2.5 and 6 amps

Delivering leading edge, innovative power solutions for more than 30 years....

Model:GTM86100-10VV-W2H-USB

May 20, 2022

OUTPUT CONFIGURATION

Common output connector options:

 L Type (Coaxial
5.5x2.5mm plug)

 C Type (Coaxial
5.5x2.1mm plug)

 K Type (Coaxial
3.5x1.3mm plug)

 LL Type (5.5x2.5mm
Locking 760k type)

 CL Type (5.5x2.1mm
Locking S761k type)

 ML2 Type (Molex
housing 43025-0200)

 YL3 Type
(KPPX-3P)

YL4 Type (KPPX-4P)

 EJ1/2/3/4/5 (EIAJ
RC-5320A type
connectors)

 MSB Type (Micro
USB)

 USBC Type (USB
Type C)

 Inquire for custom
design

 For a comprehensive list of options, [click here](#)







Contact GlobTek for your specific requirements or custom solutions.

Delivering leading edge, innovative power solutions for more than **30** years....

Model:GTM86100-10VV-W2H-USB

May 20, 2022

Approvals

Logo	Description
No Logo Applicable	CB report IEC 60601-1: 2005 + CORR. 1 (2006) + CORR. 2 (2007) and or EN 60601-1:2006 3rd Edition including 2MOOP requirements
No Logo Applicable	IEC 60335-1:2010+A1+A2
No Logo Applicable	CB for IEC 62368-1:2014 (Second Edition)
	CE Certification
	CHINA SJ/T 11364-2014, China RoHS Chart: http://en.globtek.com/globtek-rohs.php
Conforms to UL STD. 62368-1 Certified to CSA STD C22.2 NO.62368-1	Conforms to UL STD. 62368-1 Certified to CSA STD C22.2 NO.62368-1
	
	Declaration ДС № EAЭC N RU Д-US.KA01.B.10453_19 Custom Union of Russia, Belarus and Kazakhstan http://www.globtek.com/redirect/?loc=gost-certificate-eac-declaration
	Indoor Use Only - Mark is on the label or Molded in the case
EFFICIENCY LEVEL 	Efficiency: complies to section 301 of Energy Independence and Security Act (EISA) complies with Energy Star tier 2 (North America), ECP tier 2 (China), MEPS tier 2 (Australia), Code of Conduct (Europe)
RoHS	Specifications of directive 2011/65/EU Annex VI (ROHS-2) with amendment 2015/863-EU (ROHS-3) http://www.ce-mark.com/Rohs%20final.pdf
	Japan: Voluntary Control Council for Interference (VCCI)

Delivering leading edge, innovative power solutions for more than **30** years....

Model:GTM86100-10VV-W2H-USB

May 20, 2022



WEEE: Complies with EU 2012/19/EU (
http://ec.europa.eu/environment/waste/weee/index_en.htm)
Mark is on the label or Molded in the case