

Delivering leading edge, innovative power solutions for more than 30 years....

Model:GTD83050-05VV

August 17, 2022

## UL Certified Cigarette lighter plug in power supply charger with 5v USB A output

### Information

Model Number

GTD83050-05VV

Description

GTD83050-05VV, DC/DC Switching Power Supply, Vehicle/Car DC/DC Converter, DC-DC Non-Isolated, , Input Rating: 12-24 Vdc, Male Cigarette Lighter Plug, Output Rating: 5 Watts, Power rating with convection cooling (W) , 5VV in 0.1V increments, Approvals: CE; EAC; Ukraine; WEEE; RoHS; PSE; China RoHS; VCCI; ETL 62368;

Model Picture



Agency Documents

<http://www.globtek.info/certs/GTD83050/>

CE EC-Declaration

[https://www.globtek.com/pdf/ec\\_declaration/a000c00000QCcb1EAD](https://www.globtek.com/pdf/ec_declaration/a000c00000QCcb1EAD)

RoHS/RoHS2 Declaration

[https://www.globtek.com/pdf/rohs\\_cert/a000c00000QCcb1EAD](https://www.globtek.com/pdf/rohs_cert/a000c00000QCcb1EAD)

REACH Declaration

[https://www.globtek.com/pdf/iso\\_certificates/REACH.pdf](https://www.globtek.com/pdf/iso_certificates/REACH.pdf)

Conflict Minerals Declaration

<https://www.globtek.com/pdf/conflict-minerals.pdf>

Delivering leading edge, innovative power solutions for more than **30** years....

Model:GTD83050-05VV

August 17, 2022

**MODEL PARAMETERS**

Type	Vehicle/Car DC/DC Converter
Technology	DC-DC Non-Isolated
Category	DC/DC Switching Power Supply
Input Voltage	12-24 Vdc
I/P Amps (A)	1A max
Wattage (W)	5.0
Vout Range (V)	5V
Efficiency Level	
Ingress Protection	
Size (mm)	51*21 *27.1

Delivering leading edge, innovative power solutions for more than **30** years....

Model:GTD83050-05VV

August 17, 2022

## ENCLOSURE

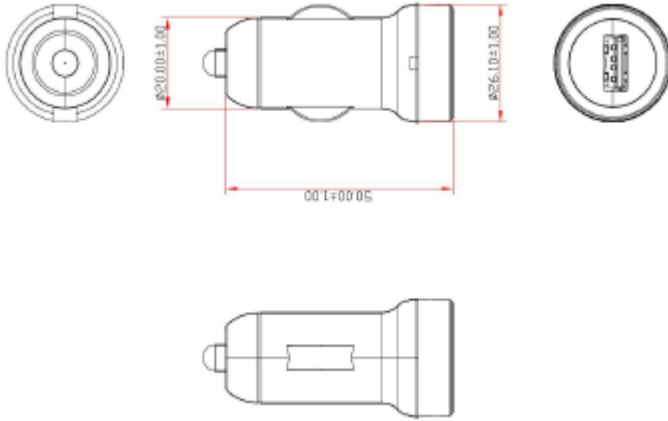

Delivering leading edge, innovative power solutions for more than **30** years....

Model:GTD83050-05VV

August 17, 2022

## RATING TABLE

Model Number	Voltage	Amps(A)	Watts(W)	RFQ
GTD83050-0505	5 V	1	5.00	<a href="#">RFQ</a>

Delivering leading edge, innovative power solutions for more than **30** years....

Model:GTD83050-05VV

August 17, 2022

## SPECIFICATIONS

INPUT VOLTAGE: 10-30VDC INPUT CURRENT: 1.0 A MAX OUTPUT VOLTAGE: + 5 V DC  
OUTPUT CURRENT: 1 A, NO LOAD TO FULL LOAD, NO MINIMUM LOAD REQUIRED OUTPUT POWER (RATED): 5 WATTS MAX  
OUTPUT RIPPLE (PEAK TO PEAK): 1% TYPICAL  
OUTPUT REGULATION (LINE/LOAD): + 5 % FOR MAIN OUTPUT, MEASURED AT O/P CONNECTOR LINE REGULATION: + 0.5 % MAX AT FULL LOAD  
TURN ON/ TURN OFF OVERSHOOT: 4% MAX 500uS MAX RECOVERY TIME FOR 25% STEP LOAD TURN-ON DELAY: 1 SEC MAX  
EFFICIENCY: 70 % TYPICAL  
SWITCHING FREQUENCY: 100 KHZ TYPICAL  
OVER-VOLTAGE PROTECTION: AUTORECOVERY OVER-CURRENT / SHORT CIRCUIT: CURRENT LIMIT OTHER PROTECTION: INPUT FUSING  
MTBF: 200,000 HOURS AT 25°C AMBIENT TEMPERATURE OPERATING TEMPERATURE: 0°C TO 40° C  
STORAGE TEMPERATURE: -20°C TO 85° C HUMIDITY: 0% TO 90% RELATIVE HUMIDITY WEIGHT: 209 g  
ROHS 2: COMPLIES WITH EU 2011/65/EU AND CHINA SJ/T 11363-2006

SAFETY APPROVALS (DESIGNED TO MEET): UL62368-1, UL60950-1, CUL 22.2# 60950-1, TUV EN60950-1

EMC, EMISSIONS: COMPLIES WITH RADIATED EMISSIONS REQUIREMENTS FROM CISPR22/EN55022  
CLASS B AND FCC PART 15 CLASS B, WHEN TESTED WITH A RESISTIVE LOAD

EMC, IMMUNITY: COMPLIES WITH APPLICABLE REQUIREMENTS FROM EN50498,  
EN61000-4-2, EN61000-4-3 and EN61000-4-8

### PROPRIETARY INFORMATION

PROPRIETARY OF GLOBTEK, INC. ANY REPRODUCTION, DISCLOSURE OR USE OF THIS DRAWING, IN WHOLE OR IN PART, IS HEREBY PROHIBITED EXCEPT AS SPECIFIED IN WRITING BY GLOBTEK, INC.

<https://www.globtek.com/datasheet/w70407>

Delivering leading edge, innovative power solutions for more than **30** years....

Model:GTD83050-05VV

August 17, 2022

## DERATING CURVE

---

Delivering leading edge, innovative power solutions for more than **30** years....

Model:GTD83050-05VV

August 17, 2022

**INPUT CONFIGURATION**

Description	
	Male Cigarette Lighter Plug

Delivering leading edge, innovative power solutions for more than 30 years....

Model:GTD83050-05VV

August 17, 2022

**OUTPUT CONFIGURATION**

Common output connector options:

 L Type (Coaxial  
5.5x2.5mm plug)

 C Type (Coaxial  
5.5x2.1mm plug)

 K Type (Coaxial  
3.5x1.3mm plug)

 LL Type (5.5x2.5mm  
Locking 760k type)

 CL Type (5.5x2.1mm  
Locking S761k type)

 ML2 Type (Molex  
housing 43025-0200)

 YL3 Type  
(KPPX-3P)

YL4 Type (KPPX-4P)

 EJ1/2/3/4/5 (EIAJ  
RC-5320A type  
connectors)

 MSB Type (Micro  
USB)

 USBC Type (USB  
Type C)

 Inquire for custom  
design

 For a comprehensive list of options, [click here](#)

Contact GlobTek for your specific requirements or custom solutions.











Delivering leading edge, innovative power solutions for more than 30 years....

Model:GTD83050-05VV

August 17, 2022

## Approvals

Logo	Description
	CE Mark: tested to comply with EN50498:2010 , EN610003-2, EN610003-3 including EN61000-4-2, EN61000-4-3, EN61000-4-4, EN61000-4-5, EN61000-4-6N EN61000-4-11; EMI: Complies with EN50498 - On label or Molded in case
	Audio/Video, Information And Communication Technology Equipment - Part 1: Safety Requirements [UL 62368-1:2014 Ed.2] Audio/Video, Information And Communication Technology Equipment - Part 1: Safety Requirements [CSA C22.2#62368-1:2014 Ed.2]
	CHINA SJ/T 11364-2014, China RoHS Chart: <a href="http://en.globtek.com/globtek-rohs.php">http://en.globtek.com/globtek-rohs.php</a>
	Declaration ДС № EAЭC N RU Д-US.KA01.B.10453_19 Custom Union of Russia, Belarus and Kazakhstan <a href="http://www.globtek.com/redirect/?loc=gost-certificate-eac-declaration">http://www.globtek.com/redirect/?loc=gost-certificate-eac-declaration</a>
 GlobTek, Inc.	JAPAN TUV R-PSE, Cert. No. JD 50471624, to J62368-1(H30) , J55032(H29),J3000(H25,[15V or less]. Please reference the following website for guidelines on PSE regulations: <a href="http://en.globtek.com/importing-ite-and-medical-power-supplies-ac-adaptors-to-japan/">http://en.globtek.com/importing-ite-and-medical-power-supplies-ac-adaptors-to-japan/</a>
RoHS	Specifications of directive 2011/65/EU Annex VI (ROHS-2) with amendment 2015/863-EU (ROHS-3) <a href="http://www.ce-mark.com/Rohs%20final.pdf">http://www.ce-mark.com/Rohs%20final.pdf</a>
 10276	Ukraine UKR Sepro (Document: <a href="http://www.globtek.com/html/iso_certificates/GT_Ukraine.pdf">www.globtek.com/html/iso_certificates/GT_Ukraine.pdf</a> )
	Japan: Voluntary Control Council for Interference (VCCI)
	WEEE: Complies with EU 2012/19/EU ( <a href="http://ec.europa.eu/environment/waste/weee/index_en.htm">http://ec.europa.eu/environment/waste/weee/index_en.htm</a> ) Mark is on the label or Molded in the case