

Delivering leading edge, innovative power solutions for more than 30 years....

Model:GTM96300-3656-T3-AP

April 1, 2020

Medical POE Injector Midspan provides IEEE802.3at Poe PSE, DEO EPS Level VI and EuP compliance, and IEC60601-1 certification

Information

Model Number	GTM96300-3656-T3-AP
Description	GTM96300-3656-T3-AP, ITE / Medical Power Supply, Desktop/External, Gigabit Power over Ethernet (IEEE802.3at PoE PSE) Power Supply AC Adaptor, , Input Rating: 100-240V~, 50-60 Hz, IEC 60320/C14 AC Inlet Connector, Class I, Earth Ground, Output Rating: 36 Watts, Power rating with convection cooling (W) , 56V in 0.1V increments, Approvals: CB 60335; CB 62368; CE; China RoHS; Class I; EAC; PSE; Level VI; VCCI; Patent US9838207B2; WEEE; Ukraine; RoHS; China RoHS; CB 60601-1-11; cRUus; ETL 62368;
Model Picture	
Agency Documents	http://www.globtek.info/certs/GTM96300-POE/
CE EC-Declaration	https://www.globtek.com/pdf/ec_declaration/a000c00000QDdumEAD
RoHS/RoHS2 Declaration	https://www.globtek.com/pdf/rohs_cert/a000c00000QDdumEAD
REACH Declaration	https://www.globtek.com/pdf/iso_certificates/REACH.pdf
Conflict Minerals Declaration	https://www.globtek.com/pdf/conflict-minerals.pdf

Delivering leading edge, innovative power solutions for more than **30** years....

Model:GTM96300-3656-T3-AP

April 1, 2020

MODEL PARAMETERS

Type	Desktop/External
Technology	Gigabit Power over Ethernet (IEEE802.3at PoE PSE) Power Supply AC Adaptor
Category	ITE / Medical Power Supply
Input Voltage	100-240V~, 50-60 Hz
I/P Amps (A)	1.0A
Wattage (W)	36.0
Vout Range (V)	56
Efficiency Level	USA DOE Level VI / Eco-design Directive 2009/125/EC, (EU) 2019/1782
Ingress Protection	IP40
Size (mm)	107*55*36

Delivering leading edge, innovative power solutions for more than 30 years....

Model:GTM96300-3656-T3-AP

April 1, 2020

ENCLOSURE

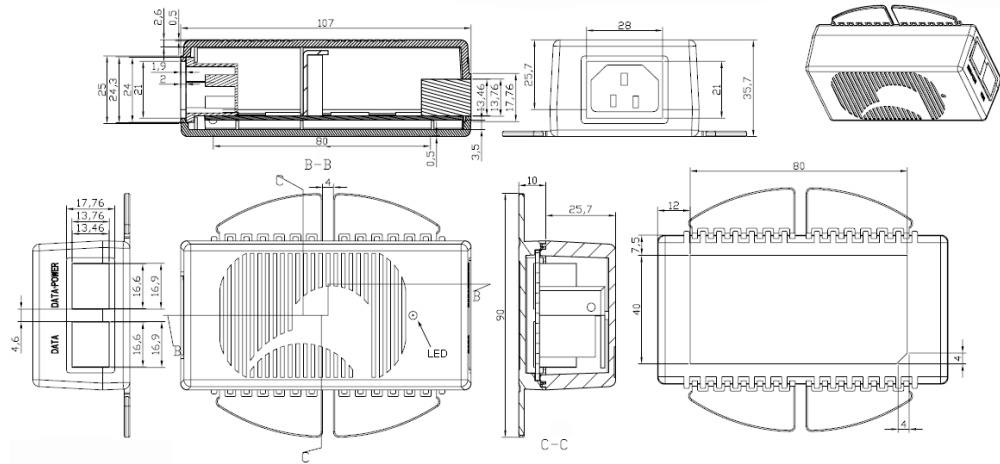

Delivering leading edge, innovative power solutions for more than **30** years....

Model:GTM96300-3656-T3-AP

April 1, 2020

RATING TABLE

Model Number	Voltage	Amps(A)	Watts(W)	RFQ
GTM96300-3656-T3-AP	56 V	0.643	36.01	RFQ

Delivering leading edge, innovative power solutions for more than **30** years....

Model:GTM96300-3656-T3-AP

April 1, 2020

SPECIFICATIONS

Delivering leading edge, innovative power solutions for more than 30 years....

Model:GTM96300-3656-T3-AP

April 1, 2020

DERATING CURVE

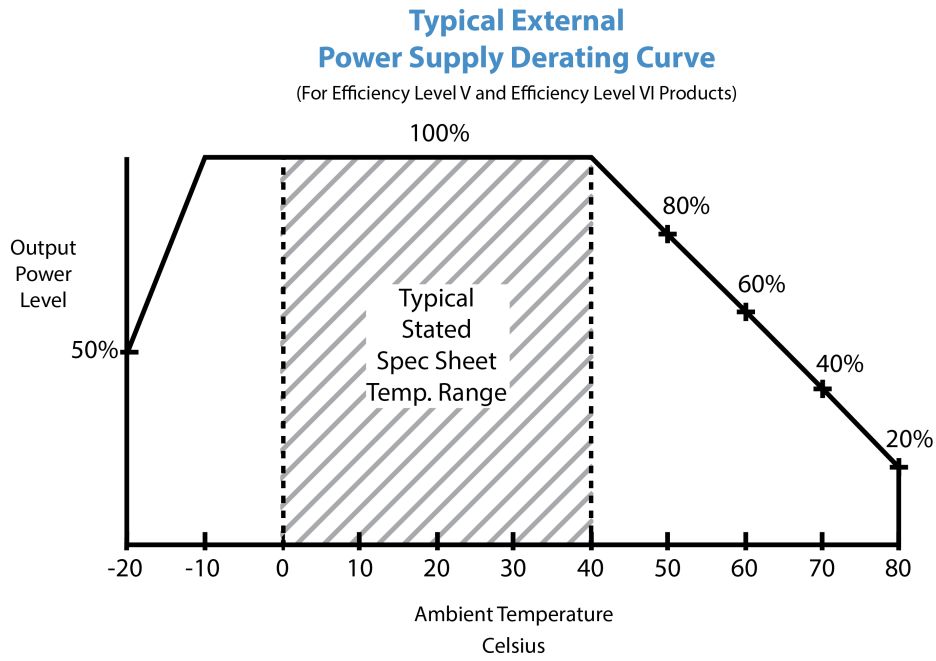

Delivering leading edge, innovative power solutions for more than 30 years...

Model:GTM96300-3656-T3-AP

April 1, 2020

INPUT CONFIGURATION

Description IEC 60320/C14 AC Inlet Connector, Class I, Earth Ground

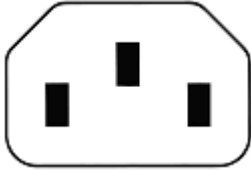

Mates with IEC 60320/C13 Plug

Optional Locking IEC60320 Receptacle and cord option available on some models by request.:

[Standard International IEC 320/C13 Cordsets](#)

Below are standard cordsets which are "not included" (unless stated above); these can be purchased separately or packaged with the power supply. Contact your Sales Engineer if the style required is not shown below. Many more available in different lengths, colors or cable material.

Stock Power Supply Cords

Part Number/ Link	Country	Plug	Termination	Length (mm)	(Ft)
3021457F701(R)	N. American (Type B)	NEMA 5-15P	IEC 320/C13	2150	7
1191068F0701(R)	N. American (Type B)	NEMA 5-15P Hospital	IEC 320/C13	2459	8
2194272M5701-T(R)	Argentina (Type I)	IRAM 2073	IEC 320/C13	2500	8
5502022M5701A(R)	Australian (Type I)	AS3112 / 3 PRONG	IEC 320/C13	2500	8
204B4272M5701(R)	Brazil (Type N)	BRAZIL	IEC 320/C13	2500	8
6023602M5701(R)	China (Type I)	CCC GR2099	IEC 320/C13	2500	8
G8014272M5701(R)	Danish (Type K)	AFSNIT SECTION 107-2-D1	IEC 320/C13	2500	8
23144272M5701-T(R)	Europe (Type E)	CEE 7/7	IEC 320/C13	2500	8
205IN4272M5701(R)	India (Type D)	India IS 1293 (also known as IA16A3 or BS546)	IEC 320/C13	2500	8
208IN4272M5701(R)	India (Type M)	India IS 1293 (also known as IA16A3 or BS546)	IEC320/C13	2500	8
377C4272M5701(R)	Israel (Type H)	ISL 377C	IEC 320/C13	2500	8
23024272M5701(R)	Italy (Type L)	CEI 23-16/VII	IEC 320/C13	2500	8
3003339F701(R) [3x1.25mm2]	Japan (Type B)	JIS 8303 / 3 PINS	IEC 320/C13	2500	8

PROPRIETARY INFORMATION

PROPRIETARY OF GLOBTEK, INC. ANY REPRODUCTION, DISCLOSURE OR USE OF THIS DRAWING, IN WHOLE OR IN PART, IS HEREBY PROHIBITED EXCEPT AS SPECIFIED IN WRITING BY GLOBTEK, INC.

<http://en.globtek.com/datasheet/id/a000c00000QDdum>

Delivering leading edge, innovative power solutions for more than **30** years....

Model:GTM96300-3656-T3-AP







April 1, 2020

3003068F2701-HK(R) [3 x 2.0mm2]					
302J115J6F0701J(R)	Japan / North America (Type B – 12A)	JIS 8303 / 3 PINS and NEMA 5-15P (PSE and UL/CUL appr)	IEC 320/C13	1830	6
302J104J6F0701J(R)	Japan / North America (Type B – 15A)	JIS 8303 / 3 PINS and NEMA 5-15P (PSE and UL/CUL appr)	IEC 320/C13	1830	6
2313K3432M5701(R)	Korea (Type F)	KS C 8305	IEC 320/C13	2500	8
5804272M5701(R)	Russia (Type F)	GOST 7396	IEC 320/C13	2500	8
2084272M5701(R)	South Africa (Type M)	South Africa SABS164-1 (16A type)	IEC 320/C13	2500	8
23214272M5701(R)	Switzerland (Type J)	SEV 1011	IEC 320/C13	2500	8
3003322M5701(R)	Taiwan (Type B)	BSMI	IEC 320/C13	2500	8
PZ0800100-2M5BK13H(R)	UK, Hong Kong, Singapore, Gulf States (Type G)	BS 1363A	IEC 320/C13	2500	8
7055002M5701A(R)	International	IEC 320 C14-C13	IEC 320/C13	2500	8

Model:GTM96300-3656-T3-AP

April 1, 2020





Approvals

Logo	Description
No Logo Applicable	IEC 60601-1
No Logo Applicable	CB for IEC 62368-1:2014 (Second Edition)
	CE Certification
No Logo Applicable	IEC 60335-1:2010 (Fifth Edition) incl. Corr. 1:2010 and Corr. 2:2011 + A1:2013
	Audio/Video, Information And Communication Technology Equipment - Part 1: Safety Requirements [UL 62368-1:2014 Ed.2] Audio/Video, Information And Communication Technology Equipment - Part 1: Safety Requirements [CSA C22.2#62368-1:2014 Ed.2]
	CHINA SJ/T 11364-2014, China RoHS Chart: http://en.globtek.com/globtek-rohs.php
	CHINA SJ/T 11364-2014, China RoHS Chart: http://en.globtek.com/globtek-rohs.php
	cRUus UL Recognized Component E341350 3rd Edition w-RM ANSI-AAMI ES60601-1 (2005 + C1:09 + A2:10) and CAN-CSA-C22.2 No. 60601-1:14 (2008)
	Declaration ДС № EAЭC N RU Д-US.KA01.B.10453_19 Custom Union of Russia, Belarus and Kazakhstan http://www.globtek.com/redirect/?loc=gost-certificate-eac-declaration
 GlobTek, Inc.	JAPAN TUV R-PSE, Cert. No. JD 50313285, to J60950-1(H26) , J55022(H22),J3000(H25)[DC30? 60V]. Please reference the following website for guidelines on PSE regulations: http://en.globtek.com/importing-ite-and-medical-power-supplies-ac-adaptors-to-japan/

Delivering leading edge, innovative power solutions for more than 30 years....

Model:GTM96300-3656-T3-AP

April 1, 2020

EFFICIENCY LEVEL VI	Efficiency: complies to section 301 of Energy Independence and Security Act (EISA) complies with Energy Star tier 2 (North America), ECP tier 2 (China), MEPS tier 2 (Australia), Code of Conduct (Europe)
	Morocco SDoC declaration http://www.globtek.info/certs/Morocco%20SDoC%20Declaration/
Patent US9838207B2	Protected by US and international patents, US patent number US9838207B2
RoHS	Specifications of directive 2011/65/EU Annex VI (ROHS-2) with amendment 2015/863-EU (ROHS-3) http://www.ce-mark.com/Rohs%20final.pdf
 10276	Ukraine UKRSepra (Document: www.globtek.com/html/iso_certificates/GT_Ukraine.pdf
	Japan: Voluntary Control Council for Interference (VCCI)
	WEEE: Complies with EU 2012/19/EU (http://ec.europa.eu/environment/waste/wEEE/index_en.htm) Mark is on the label or Molded in the case