

Delivering leading edge, innovative power solutions for more than 30 years....

Model:GT-41078-WWVV-X.X-USB

January 16, 2021

GT-41078-WWVV-X.X-USB

Information

Model Number

GT-41078-WWVV-X.X-USB

Description

GT-41078-WWVV-X.X-USB, ITE Power Supply, Wall Plug-in, Regulated Switchmode AC-DC Power Supply AC Adaptor, , Input Rating: 100-240V~, 50-60 Hz, Blade Options for Q Series Wall Plug-in Power Supplies, Output Rating: 5 Watts, Power rating with convection cooling (W) , 5V in 0.1V increments, Approvals: EAC; LPS 60950; SIQ; Ukraine; Serbia; CCC; PSE; Level V; RoHS; FCC; China RoHS; CB 60950; cULus; South Africa; VCCI; SGS (Brazil); Taiwan BSMI (5V only); Saudi; Israel (5V only); RCM; Korea (5V TO 6V); WEEE; Double Insulation; CE; IRAM;

Model Picture



Agency Documents

<http://www.globtek.info/certs/GT-41078-USB/>

CE EC-Declaration

https://www.globtek.com/pdf/ec_declaration/a0O30000007P7YIEA0

RoHS/RoHS2 Declaration

https://www.globtek.com/pdf/rohs_cert/a0O30000007P7YIEA0

REACH Declaration

https://www.globtek.com/pdf/iso_certificates/REACH.pdf

Conflict Minerals Declaration

<https://www.globtek.com/pdf/conflict-minerals.pdf>

Delivering leading edge, innovative power solutions for more than **30** years....

Model:GT-41078-WWVV-X.X-USB

January 16, 2021

MODEL PARAMETERS

Type	Wall Plug-in
Technology	Regulated Switchmode AC-DC Power Supply AC Adaptor
Category	ITE Power Supply
Input Voltage	100-240V~, 50-60 Hz
I/P Amps (A)	0.2A
Wattage (W)	5.0
Vout Range (V)	5
Efficiency Level	V
Ingress Protection	
Size (mm)	71*41*31.5

Delivering leading edge, innovative power solutions for more than 30 years....

Model:GT-41078-WWVV-X.X-USB

January 16, 2021

ENCLOSURE

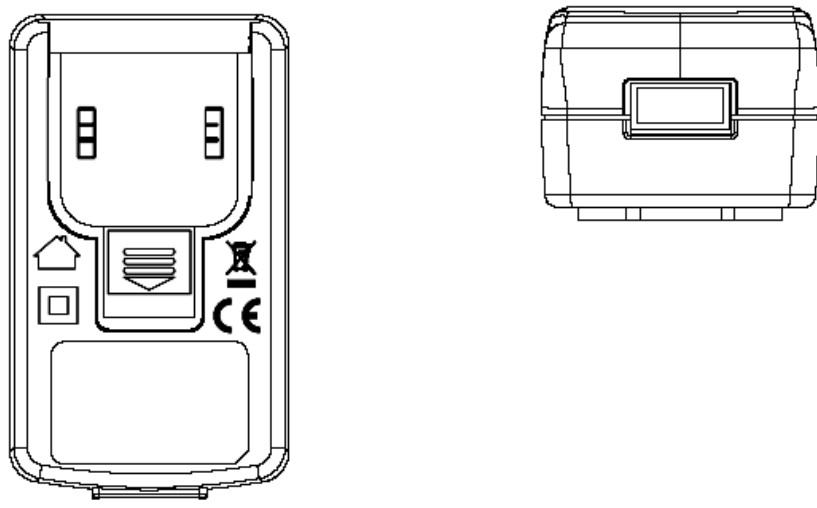
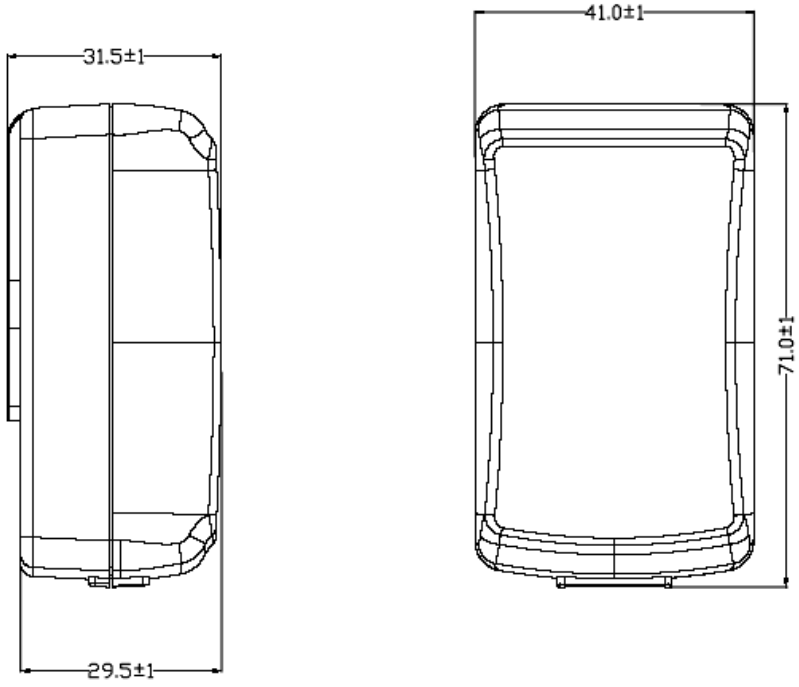

Delivering leading edge, innovative power solutions for more than **30** years....

Model:GT-41078-WWVV-X.X-USB

January 16, 2021

RATING TABLE

Model Number	Voltage	Amps(A)	Watts(W)	RFQ
GT-41078-0505-USB	5 V	1	5.00	RFQ
GT-41078-0506-0.4-USB	5.6 V	0.89	4.98	RFQ
GT-41078-0506-USB	6 V	0.83	4.98	RFQ

Model:GT-41078-WWVV-X.X-USB

January 16, 2021

SPECIFICATIONS

A) ELECTRICAL SPECIFICATIONS:

01. Input Voltage: Specified 90-264 Vac, Nameplate rated: 100-240Vac
02. Input Frequency: Specified 47-63 Hz, Nameplate rated 50-60Hz
03. Output Regulation: +/- 5% measured at the output connector measured at the end of a 1 meter USB cordset employing #22 Gauge conductors
04. Line Voltage Regulation: +/- 1% typical measured at the output connector measured at the end of a 1 meter USB cordset employing #22 Gauge conductors
05. Output Ripple (Vp-p): +/-1% or 100 mV whichever is greater measured at the end of a 1 meter USB cordset employing #22 Gauge conductors. Measured at 20 MHz bandwidth with 0.1 uf ceramic capacitor in parallel with 10 uf electrolytic capacitor connected at the end of the output connector.
06. Turn-ON Delay: 3000 mS, maximum @ full load, nominal line
07. Hold-Up Time: 8 mS typical @ nominal input voltage and full load
08. Inrush Current: 30/60A maximum cold start @ 115/230Vac input
09. Switching Frequency: 66.5 KHz typical

B) PROTECTION

01. Over-Voltage: Electronically Protected unit will auto recover upon removal of fault
02. Short Circuit: Electronically Protected unit will auto recover upon removal of fault
03. Input Protection: Input line fusing
04. ROHS 2: Complies with EU 2011/65/EU and China SJ/T 11363-2006

C) SAFETY

01. Dielectric Withstand Voltage: 4242Vdc from primary to secondary
02. Touch Current: <0.25mA @ 240Vac input voltage

D) OTHER:

01. MTBF: 200,000 Hours @ 25°C ambient temperature
02. Operating Temperature: 0°C to 40°C ambient temperature
03. Humidity: 0% to 90% relative humidity
04. Storage Temperature: -10°C to 80°C
05. Cooling: Convection

E) ENCLOSURE

01. Housing: High impact plastic, 94V0 polycarbonate, non-vented
02. Size: 71 x 41 x 31.5 ± 1mm
03. Markings: Label and/or Pad Printed and/or Molded in the case

Delivering leading edge, innovative power solutions for more than **30** years....

Model:GT-41078-WWVV-X.X-USB

January 16, 2021

DERATING CURVE

Delivering leading edge, innovative power solutions for more than 30 years....

Model:GT-41078-WWVV-X.X-USB

January 16, 2021

INPUT CONFIGURATION

Description Blade Options for Q Series Wall Plug-in Power Supplies

 Data Sheet: <http://en.globtek.com/interchangeable-blades.php>

 Insertion Instructions: <http://www.globtek.com/pdf/Instructions-Interchangeable-Blades.pdf>

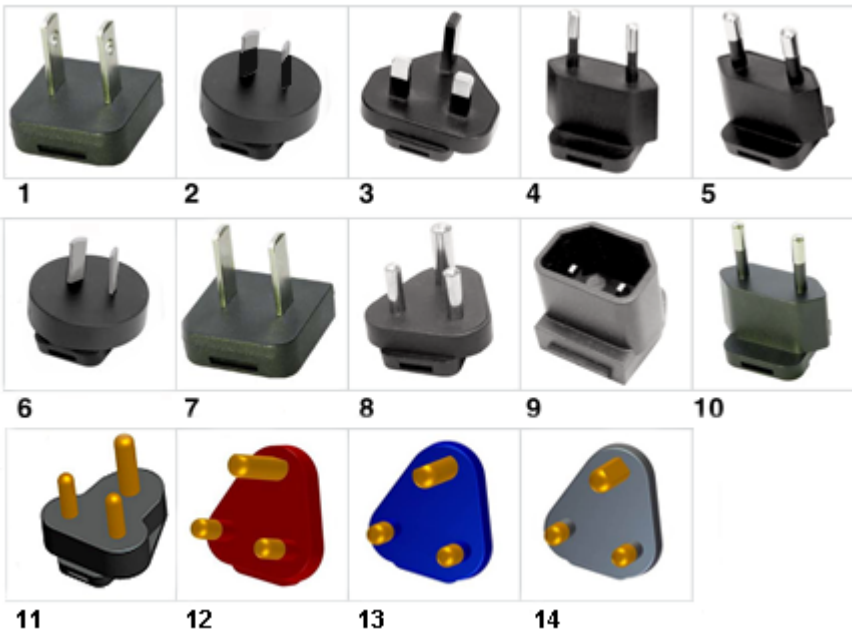
 Video: [Q-Blade Style Instruction Video](#)

INPUT CONNECTOR: Q-Socket (below are available blades configurations which are "not included" (unless stated above); can be purchased separately, package with power supply or as a separate "Q-KIT" if specified

01. United States / Canada / Japan NEMA 1-15P/ IEC PLUG Type A [WORKS IN PLUG B] configuration: NA 2 blades, Class II; US/CA/JP P/N: Q-NA(R)
02. Australian AS 3112 configuration: SAA 2 blade/ IEC TYPE I, Class II; AU P/N: Q-SAA(R)
03. UK BS 1363 configuration: UK 3 blade with dummy Ground/ IEC TYPE G, Class II; GB P/N: Q-UK(R)
04. European CEE 7/16 configuration: Europlug 2 pins/ IEC TYPE C [WORKS IN TYPE E&F], Class II; EU P/N: Q-EU(R)
05. Korean KS C8305 configuration: 2 pins/SIMILAR TO IEC TYPE C, Class II; KR P/N: Q-KR(R)
06. Argentina IRAM 2073 configuration: 2 blades/SIMILAR TO IEC TYPE I; AR P/N: Class II Q-AR(R)
07. China GB 2099 configuration: 2 blades/SIMILAR TO TYPE A, Class II; CN P/N:Q-CN(R)
08. India IS 1293 6A/BS546 configuration: 5A, 3 pins with Dummy Ground, Class II/IEC TYPE D; IN P/N: Q-IN(R)
09. IEC60320/C18 Inlet, Class II; P/N: Q-C18(R)
10. Brazilian NBR6147 configuration: 2 pins, Class II;SIMILAR TO IEC TYPE C BR P/N: Q-BR(R)
11. South Africa SABS164-1, 3 round prongs, Class II + dummy ground, IEC TYPE M P/N: Q-SANS164-1-16A(R)
12. South Africa SABS164-4, 3 round prongs with a notched prong @ 0°, Class II + dummy ground, IEC TYPE M Red, P/N: Q-SANS164-4L-16A(R)
13. South Africa SABS164-4, 3 round prongs with a notched prong @ -53°, Class II + dummy ground, Blue, IEC TYPE M,

PROPRIETARY INFORMATION

PROPRIETARY OF GLOBTEK, INC. ANY REPRODUCTION, DISCLOSURE OR USE OF THIS DRAWING, IN WHOLE OR IN PART, IS HEREBY PROHIBITED EXCEPT AS SPECIFIED IN WRITING BY GLOBTEK, INC.

<http://en.globtek.com/datasheet/id/a003000007P7YI>

Delivering leading edge, innovative power solutions for more than **30** years....

Model:GT-41078-WWVV-X.X-USB

January 16, 2021

P/N:
Q-SANS164-4C-16A(R)
14. South Africa SABS164-4, 3 round prongs with a notched prong @ +53°, Class II + dummy ground, Black,IEC TYPE M
P/N:
Q-SANS164-4R-16A(R)

Kits

01. Q-KIT: 1,2,3,4 above
02. Q-KIT-INTL: 2,3,4 above
03. Q-KIT-6: 1,2,3,4,5,6 above
04. Q-KIT-7: 1,2,3,4,5,6,7 above
05. Q-KIT-8: 1,2,3,4,5,6,7,8 above

Delivering leading edge, innovative power solutions for more than 30 years....

Model:GT-41078-WWVV-X.X-USB

January 16, 2021

OUTPUT CONFIGURATION

Common output connector options:

 L Type (Coaxial
5.5x2.5mm plug)

 C Type (Coaxial
5.5x2.1mm plug)

 K Type (Coaxial
3.5x1.3mm plug)

 LL Type (5.5x2.5mm
Locking 760k type)

 CL Type (5.5x2.1mm
Locking S761k type)

 ML2 Type (Molex
housing 43025-0200)

 YL3 Type
(KPPX-3P)

YL4 Type (KPPX-4P)

 EJ1/2/3/4/5 (EIAJ
RC-5320A type
connectors)

 MSB Type (Micro
USB)

 USBC Type (USB
Type C)

 Inquire for custom
design

 For a comprehensive list of options, [click here](#)

Contact GlobTek for your specific requirements or custom solutions.

Delivering leading edge, innovative power solutions for more than 30 years....

Model:GT-41078-WWVV-X.X-USB

January 16, 2021











Approvals

Logo	Description
  PRECAUCION: PARA USO EN EQUIPOS ELECTRONICOS SOLAMENTE	Argentina UL certificate 15AR19294.1 for GT-41078-0505-USB
 R32282 RoHS (Pb)	Taiwan BSMI 5V design only; http://www.bsmi.gov.tw/wSite/ct?xItem=4072&ctNode=8167=2
No Logo	CB Certificate IEC 60950-1:2005 (2nd Edition), Am 1: 2009, CB report IEC 60950-1:2005 (2nd Edition), Am 1: 2009 and EN 60950-1:2006 + Am 1:2010 + Am 11:2009 + Am 12:2011
	CCC to GB4943.1-2011; GB/T9254-2008 GB17625.1-2012, Tropical <2000
	CE Certification Class II CE Mark: tested to comply with EN55022:2006/A1:2007 Class B, EN610003-2, EN610003-3 including EN61000-4-2, EN61000-4-3, EN61000-4-4, EN61000-4-5, EN61000-4-6N EN61000-4-11; EMI: Complies with EN55011 CLASS B and FCC Part 15 B
	CHINA SJ/T 11364-2014, China RoHS Chart: http://en.globtek.com/globtek-rohs.php
	UL60950-1, cULus to UL 60950-1, 2nd Edition, 2007-03-27 and CSA C22.2 No. 60950-1-07, 2nd Edition, 2007-03
	

Delivering leading edge, innovative power solutions for more than 30 years....

Model:GT-41078-WWVV-X.X-USB





January 16, 2021

	Certification # TC RU AR46.B.75423 Custom Union of Russia, Belarus and Kazakhstan
	FCC PART 15 CLASS B
	Electric strength Of Israel Standard SI 60950 Part 1 ? Safety of information technology equipment: General requirements, Feb. 2012. (5 Volts Only)
	Korea KET KC Mark GT-41078-0505-USB HU10499-13014A (5V 5.1V 5.2V 5.3V 5.4V 5.5V 5.6V 5.7V 5.8V 5.9V 6V)
	Efficiency: complies to section 301 of Energy Independence and Security Act (EISA) complies with Energy Star tier 2 (North America), ECP tier 2 (China), MEPS tier 2 (Australia), Code of Conduct (Europe)
LPS	Limited Power Source 60950
 GlobTek, Inc.	JAPAN TUV Rheinland-PSE GlobTek Inc to J60950-1(H26) , J55022(H22),J3000(H25).Please follow the procedure listed in the following link for proper import to Japan: http://en.globtek.com/importing-to-japan.php .
 SAA131160EA	RCM certificate SAA131160EA; Australia and New Zealand Regulatory Compliance, Mark (http://rcm.standards.org.au/rcmfaq/rcmfaq.htm)
RoHS	Specifications of directive 2011/65/EU Annex VI (ROHS-2) with amendment 2015/863-EU (ROHS-3) http://www.ce-mark.com/Rohs%20final.pdf
	Saudi Arabia approval to IEC 60950-1:2005
	Serbia Approval - Conformity mark must be at least 5 mm high.
	SGS (Brazil) to IEC 60950-1_2005(ed.2) + A1 2009 +A2 2013 EN60950-1:2006 + A11: 2009 + A1: 2010 + A12: 2011 + A2: 2013

Delivering leading edge, innovative power solutions for more than **30** years....

Model:GT-41078-WWVV-X.X-USB

January 16, 2021

 IEC/EN60950-1	SIQ Mark License EN60950-1
No Logo	12
 10276	Ukraine UKRSepto (Document: www.globtek.com/html/iso_certificates/GT_Ukraine.pdf)
	Japan: Voluntary Control Council for Interference (VCCI)
	WEEE: Complies with EU 2012/19/EU (http://ec.europa.eu/environment/waste/weee/index_en.htm) Mark is on the label or Molded in the case