

Delivering leading edge, innovative power solutions for more than 30 years....

Model:GT-43004P120VV-x.x-T3

March 28, 2020

120W - 150W External Power AC Adapter Power Supply available from 12v - 24V

Information

Model Number

GT-43004P120VV-x.x-T3

Description

GT-43004P120VV-x.x-T3, ITE Power Supply, Desktop/External, Regulated Switchmode AC-DC Power Supply AC Adaptor, , Input Rating: 100-240V~, 50-60 Hz, IEC 60320/C14 AC Inlet Connector, Class I, Earth Ground, Output Rating: 120 Watts, Power rating with convection cooling (W) , 12-24V in 0.1V increments, Approvals: S-Mark 60950; Level V; PSE; Ukraine; China RoHS; CE; WEEE; Class I; VCCI; RoHS; CB 60950; NOM; India; cULus; EC; Israel; Peru; CE; RCM; Taiwan BSMI; CCC; HKSM; IRAM; Korea (24V Only); Saudi; Singapore (24V); South Africa; South Africa; PSE; PSE; EAC; Malaysia; FCC; SGS (Brazil);

Model Picture



Agency Documents

<http://www.globtek.info/certs/GT-43004P-T3%20-T3A/>

CE EC-Declaration

https://www.globtek.com/pdf/ec_declaration/a003000007P7YxEAK

RoHS/RoHS2 Declaration

https://www.globtek.com/pdf/rohs_cert/a003000007P7YxEAK

REACH Declaration

https://www.globtek.com/pdf/iso_certificates/REACH.pdf

Conflict Minerals Declaration

<https://www.globtek.com/pdf/conflict-minerals.pdf>

Delivering leading edge, innovative power solutions for more than **30** years....

Model:GT-43004P120VV-x.x-T3

March 28, 2020

MODEL PARAMETERS

Type	Desktop/External
Technology	Regulated Switchmode AC-DC Power Supply AC Adaptor
Category	ITE Power Supply
Input Voltage	100-240V~, 50-60 Hz
I/P Amps (A)	2.0A
Wattage (W)	120.0
Vout Range (V)	12-24
Efficiency Level	V
Ingress Protection	Indoor Use
Size (mm)	172.5*72.2*42.0

Delivering leading edge, innovative power solutions for more than 30 years....

Model:GT-43004P120VV-x.x-T3

March 28, 2020

ENCLOSURE

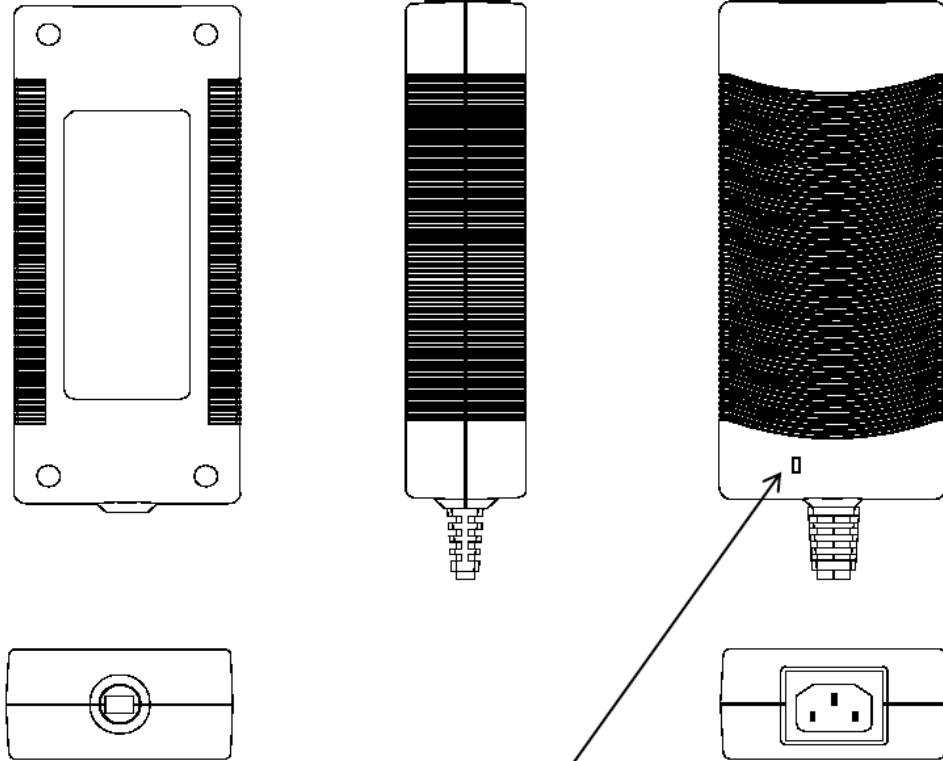

LED INDICATOR
GREEN = "ON"

Delivering leading edge, innovative power solutions for more than **30** years....

Model:GT-43004P120VV-x.x-T3

March 28, 2020

RATING TABLE

Model Number	Voltage	Amps(A)	Watts(W)	RFQ
GT-43004P12012-T3	12 V	10	120.00	RFQ
GT-43004P12016-3.2-T3	12.8 V	9.37	119.94	RFQ
GT-43004P12016-2.5-T3	13.5 V	8.88	119.88	RFQ
GT-43004P12016-1.0-T3	15 V	8	120.00	RFQ
GT-43004P12016-T3	16 V	7.5	120.00	RFQ
GT-43004P12019-1.0-T3	18 V	6.66	119.88	RFQ
GT-43004P12019-T3	19 V	6.31	119.89	RFQ
GT-43004P15024-T3	24 V	6.25	150.00	RFQ
GT-43004P12024-T3	24 V	5	120.00	RFQ

Model:GT-43004P120VV-x.x-T3

March 28, 2020

SPECIFICATIONS

A) ELECTRICAL SPECIFICATIONS:

01. Input Voltage: Specified 90-264 Vac, Nameplate rated: 100-240Vac
02. Input Frequency: Specified 47-63 Hz, Nameplate rated 50-60Hz
03. Output Regulation: +/- 5% measured at the output connector
04. Line Voltage Regulation: +/- 1% typical measured at the output connector
05. Output Ripple (Vp-p): +/-1% or 200 mV whichever is greater, measured at 20 MHz bandwidth with 0.1 uf ceramic capacitor in parallel with 47 uf electrolytic capacitor connected at the end of the output connector at nominal line
06. Turn-ON/OFF Overshoot: 10% maximum, 1 mS typical recovery time for 25% step load
07. Turn-ON Delay: 3000 mS, maximum @ full load, nominal line
08. Hold-Up Time: 10 mS typical @ nominal input voltage and full load
09. Inrush Current: 40A typical 115VAC input and 60A typical at 230VAC input
10. Switching Frequency: 100 KHz typical

B) PROTECTION

01. Over-Voltage: AC cycling required to reset output
02. Short Circuit: AC cycling required to reset output
03. Input Protection: Input line fusing

C) SAFETY

01. Dielectric Withstand Voltage: 4242 Vdc from primary to secondary
02. Touch Current: <0.25mA @ 240Vac input voltage
03. Earth continuity test:<0.1 Ohm or < 0.2 Ohm when with a non-detachable Power Supply cord, Class I Only
04. ROHS 2: Complies with EU 2011/65/EU and China SJ/T 11363-2006

D) OTHER:

01. MTBF: 200,000 Hours @ 25°C ambient temperature
02. Operating Temperature: 0°C to 40°C ambient temperature
03. Humidity: 0% to 90% relative humidity
04. Storage Temperature: -10°C to 80°C
05. Cooling: Convection

E) ENCLOSURE

01. Housing: High impact plastic, 94V0 polycarbonate, non-vented
02. Size: 172.5*72.2*42.0 +/-1.0 mm
03. Markings: Label and/or Pad Printed and/or Molded in the case
04. GREEN LED to indicate power ON

Delivering leading edge, innovative power solutions for more than **30** years....

Model:GT-43004P120VV-x.x-T3

March 28, 2020

DERATING CURVE

Delivering leading edge, innovative power solutions for more than 30 years....

Model:GT-43004P120VV-x.x-T3

March 28, 2020

INPUT CONFIGURATION

Description IEC 60320/C14 AC Inlet Connector, Class I, Earth Ground

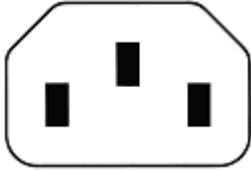

Mates with IEC 60320/C13 Plug

Optional Locking IEC60320 Receptacle and cord option available on some models by request.:

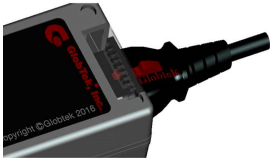
[Standard International IEC 320/C13 Cordsets](#)

Below are standard cordsets which are "not included" (unless stated above); these can be purchased separately or packaged with the power supply. Contact your Sales Engineer if the style required is not shown below. Many more available in different lengths, colors or cable material.

Stock Power Supply Cords

Part Number/ Link	Country	Plug	Termination	Length (mm)	(Ft)
3021457F701(R)	N. American (Type B)	NEMA 5-15P	IEC 320/C13	2150	7
1191068F0701(R)	N. American (Type B)	NEMA 5-15P Hospital	IEC 320/C13	2459	8
2194272M5701-T(R)	Argentina (Type I)	IRAM 2073	IEC 320/C13	2500	8
5502022M5701A(R)	Australian (Type I)	AS3112 / 3 PRONG	IEC 320/C13	2500	8
204B4272M5701(R)	Brazil (Type N)	BRAZIL	IEC 320/C13	2500	8
6023602M5701(R)	China (Type I)	CCC GR2099	IEC 320/C13	2500	8
G8014272M5701(R)	Danish (Type K)	AFSNIT SECTION 107-2-D1	IEC 320/C13	2500	8
23144272M5701-T(R)	Europe (Type E)	CEE 7/7	IEC 320/C13	2500	8
205IN4272M5701(R)	India (Type D)	India IS 1293 (also known as IA16A3 or BS546)	IEC 320/C13	2500	8
208IN4272M5701(R)	India (Type M)	India IS 1293 (also known as IA16A3 or BS546)	IEC320/C13	2500	8
377C4272M5701(R)	Israel (Type H)	ISL 377C	IEC 320/C13	2500	8
23024272M5701(R)	Italy (Type L)	CEI 23-16/VII	IEC 320/C13	2500	8
3003339F701(R) [3x1.25mm2]	Japan (Type B)	JIS 8303 / 3 PINS	IEC 320/C13	2500	8

PROPRIETARY INFORMATION

PROPRIETARY OF GLOBTEK, INC. ANY REPRODUCTION, DISCLOSURE OR USE OF THIS DRAWING, IN WHOLE OR IN PART, IS HEREBY PROHIBITED EXCEPT AS SPECIFIED IN WRITING BY GLOBTEK, INC.

<http://en.globtek.com/datasheet/id/a0030000007P7Yx>

Delivering leading edge, innovative power solutions for more than **30** years....

Model:GT-43004P120VV-x.x-T3

March 28, 2020

3003068F2701-HK(R) [3 x 2.0mm2]					
302J115J6F0701J(R)	Japan / North America (Type B – 12A)	JIS 8303 / 3 PINS and NEMA 5-15P (PSE and UL/CUL appr)	IEC 320/C13	1830	6
302J104J6F0701J(R)	Japan / North America (Type B – 15A)	JIS 8303 / 3 PINS and NEMA 5-15P (PSE and UL/CUL appr)	IEC 320/C13	1830	6
2313K3432M5701(R)	Korea (Type F)	KS C 8305	IEC 320/C13	2500	8
5804272M5701(R)	Russia (Type F)	GOST 7396	IEC 320/C13	2500	8
2084272M5701(R)	South Africa (Type M)	South Africa SABS164-1 (16A type)	IEC 320/C13	2500	8
23214272M5701(R)	Switzerland (Type J)	SEV 1011	IEC 320/C13	2500	8
3003322M5701(R)	Taiwan (Type B)	BSMI	IEC 320/C13	2500	8
PZ0800100-2M5BK13H(R)	UK, Hong Kong, Singapore, Gulf States (Type G)	BS 1363A	IEC 320/C13	2500	8
7055002M5701A(R)	International	IEC 320 C14-C13	IEC 320/C13	2500	8

Delivering leading edge, innovative power solutions for more than 30 years....

Model:GT-43004P120VV-x.x-T3

March 28, 2020

OUTPUT CONFIGURATION

Common output connector options:

 L Type (Coaxial
5.5x2.5mm plug)

 C Type (Coaxial
5.5x2.1mm plug)

 K Type (Coaxial
3.5x1.3mm plug)

 LL Type (5.5x2.5mm
Locking 760k type)

 CL Type (5.5x2.1mm
Locking S761k type)

 ML2 Type (Molex
housing 43025-0200)

 YL3 Type
(KPPX-3P)

YL4 Type (KPPX-4P)

 EJ1/2/3/4/5 (EIAJ
RC-5320A type
connectors)

 MSB Type (Micro
USB)

 USBC Type (USB
Type C)

 Inquire for custom
design

 For a comprehensive list of options, [click here](#)





Contact GlobTek for your specific requirements or custom solutions.

Delivering leading edge, innovative power solutions for more than 30 years....

Model:GT-43004P120VV-x.x-T3

March 28, 2020







Approvals

Logo	Description
 R32282 RoHS (Pb)	BSMI Taiwan GT-43004P15024-T3 (24V only); CNS143361-1 (99) CNS13438 (95) http://www.bsmi.gov.tw/wSite/ct?xItem=4072&ctNode=8167=2
No Logo Applicable	CB report 60950-1 2nd Ed
	CCC to GB4943.1-2011 GB9254-2008 GB17625.1-2012 with Tropical and Altitude above 2000m approval
	CE Certification Class II CE Mark: tested to comply with EN 55032.2012+AC.2013 EN 61000-3-2.2014 EN 61000-3-3.2013 EN 55024.2010
	CE Mark: tested to comply with EN55022:2006/A1:2007 Class B, EN610003-2, EN610003-3 including EN61000-4-2, EN61000-4-3, EN61000-4-4, EN61000-4-5, EN61000-4-6N EN61000-4-11; EMI: Complies with EN55011 CLASS B and FCC Part 15B - On label or Molded in case
	CHINA SJ/T 11364-2014, China RoHS Chart: http://en.globtek.com/globtek-rohs.php
	UL60950-1, cULus to UL 60950-1, 2nd Edition, 2007-03-27 and CSA C22.2 No. 60950-1-07, 2nd Edition, 2007-03 (5V and 12V)
	Certification # TC RU AR46.B.69004 Custom Union of Russia, Belarus and Kazakhstan
No Logo	EC-Conformity Declaration: http://www.globtek.com/html/iso_certificates/EC-DECLARATION.pdf , REACH 144 SVHC: http://www.globtek.com/html/iso_certificates/Reach144.pdf

Delivering leading edge, innovative power solutions for more than 30 years....

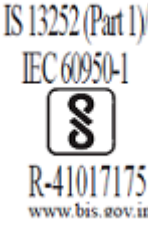
Model:GT-43004P120VV-x.x-T3



March 28, 2020

	<p>FCC PART 15 CLASS B</p>
 L00480 A -1	<p>Hong Kong Safety Mark License IEC60950-1:2005 + A1:2009</p>
 R-41017175 www.bis.gov.in	<p>Bureau Of Indian Standards for GT-43004P15024-T3</p>
	<p>Indoor Use Only - Mark is on the label or Molded in the case</p>
 DC-E-G71-001.6 PRECAUCION: PARA USO EN EQUIPOS ELECTRONICOS SOLAMENTE	<p>IRAM certificate DC-E-G71-001.6 to IEC 60950 + A1:2009</p>
<p>ITE כוח קצו</p>	<p>To test compliance with the requirements of Israel Standard SI 60950 Part 1 ? Safety of information technology equipment: General requirements, Feb. 2012.</p>
 GlobTek, Inc.	<p>JAPAN TUV R-PSE, Cert. No. JD 50313287, to J60950-1(H26) , J55022(H22),J3000(H25)[15V or less]. Please reference the following website for guidelines on PSE regulations: http://en.globtek.com/importing-ite-and-medical-power-supplies-ac-adaptors-to-japan/</p>
 GlobTek, Inc.	<p>JAPAN TUV R-PSE, Cert. No. JD 50313287, to J60950-1(H26) , J55022(H22),J3000(H25)[DC15?30V]. Please reference the following website for guidelines on PSE regulations: http://en.globtek.com/importing-ite-and-medical-power-supplies-ac-adaptors-to-japan/</p>

Delivering leading edge, innovative power solutions for more than **30** years....

Model:GT-43004P120VV-x.x-T3





March 28, 2020

 직류전원장치 AC/DC ADAPTER KTC HU10499-14018A MSIP-REM-GSZ-GT-43004P15024 전기용품안전관리법에 의한 표시 최저소비효율기준 만족 제품 모델명:GT-43004P15024-T3 Mfr. Name: GLOBTEK (SUZHOU) CO.,LTD A/S Center:10-6221-6100	Korea KET KC Mark GT-43004P15024-T3 &T3A HU10499-14018A (24V Only)
EFFICIENCY LEVEL 	Efficiency: complies to section 301 of Energy Independence and Security Act (EISA) complies with Energy Star tier 2 (North America), ECP tier 2 (China), MEPS tier 2 (Australia), Code of Conduct (Europe)
No Logo	Malaysia ST Release Letter GT-43004P-T* IEC60950-1:2005 (ED.2) + A1:2009 No logo
 Fuente de alimentación de ITE	NOM (Mexico) GT-43004P5024-T3 to NOM-001-SCFI-1993 (24 Volts only)
No Logo	Peru MTC 2034-2016-MTC/29 for GT-43004P15024-T3 No logo
 GlobTek, Inc.	JAPAN TUV Rheinland-PSE GlobTek Inc to J60950-1(H26) , J55022(H22),J3000(H25).Please follow the procedure listed in the following link for proper import to Japan: http://en.globtek.com/importing-to-japan.php .
 H136 SAA121417EA	RCM certificate GT-43004PWWVVV-X.X-TZ; Australia and New Zealand Regulatory Compliance, Mark (http://rcm.standards.org.au/rcmfaq/rcmfaq.htm)
RoHS	Specifications of directive 2011/65/EU Annex VI (ROHS-2) with amendment 2015/863-EU (ROHS-3) http://www.ce-mark.com/Rohs%20final.pdf
	S-Mark Certificate EN 60950-1:2006 + A11:2009 + A1:2010 + A12:2011+A2:2013 (http://www.intertek.com/marks/s/)
إمدادات الطاقة	Saudi Arabia approval to IEC 60950-2005

Delivering leading edge, innovative power solutions for more than **30** years....

Model:GT-43004P120VV-x.x-T3

March 28, 2020

	SGS (Brazil) to IEC 60950-1: 2005(Second edition) + Am1:2009 +Am2:2013 (12 - 24 Volts)
	Singapore GT-43004P15024-T3 ICE 60950-1:2005 + A1:2009 +A2:2013
No Logo	12
No Logo	12
	Ukraine UKRSepro (Document: www.globtek.com/html/iso_certificates/GT_Ukraine.pdf)
	Japan: Voluntary Control Council for Interference (VCCI)
	WEEE: Complies with EU 2012/19/EU (http://ec.europa.eu/environment/waste/weee/index_en.htm) Mark is on the label or Molded in the case