

Delivering leading edge, innovative power solutions for more than **30** years....

Model:GT-41062-WWVV-T3

April 15, 2021

GT-41062-WWVV-T3

Information

Model Number

GT-41062-WWVV-T3

Description

GT-41062-WWVV-T3, ICT/ITE Power Supply, Desktop/External, Regulated Switchmode AC-DC Power Supply AC Adaptor, , Input Rating: 100-240V~, 50-60 Hz, IEC 60320/C14 AC Inlet Connector, Class I, Earth Ground, Output Rating: 18 Watts, Power rating with convection cooling (W) , 5-24V in 0.1V increments, Approvals: EAC; RCM; UKCA; CB 62368; CB 60950; CCC; CE; WEEE; Ukraine; IP40; Korea (12V Only); Korea (18V, 20V, 24V Only); NrCAN; SIQ; cUL 60950; VCCI; Class I; RoHS; China RoHS; LPS 60950; Level IV; PSE; Korea (9V Only); Korea (15V Only); Level V (24-48 Volts only); PSE; PSE; IRAM;

Model Picture



Agency Documents

<http://www.globtek.info/certs/GT-41062-T2-T3-T3A/>

CE EC-Declaration

https://www.globtek.com/pdf/ec_declaration/a0O30000007P7Z3EAK

RoHS/RoHS2 Declaration

https://www.globtek.com/pdf/rohs_cert/a0O30000007P7Z3EAK

REACH Declaration

https://www.globtek.com/pdf/iso_certificates/REACH.pdf

Conflict Minerals Declaration

<https://www.globtek.com/pdf/conflict-minerals.pdf>

Delivering leading edge, innovative power solutions for more than **30** years....

Model:GT-41062-WWVV-T3

April 15, 2021

MODEL PARAMETERS

Type	Desktop/External
Technology	Regulated Switchmode AC-DC Power Supply AC Adaptor
Category	ICT/ITE Power Supply
Input Voltage	100-240V~, 50-60 Hz
I/P Amps (A)	0.6A
Wattage (W)	18.0
Vout Range (V)	5-24
Efficiency Level	IV
Ingress Protection	
Size (mm)	80.6*50.0*31.0

Delivering leading edge, innovative power solutions for more than 30 years....

Model:GT-41062-WWVV-T3

April 15, 2021

ENCLOSURE

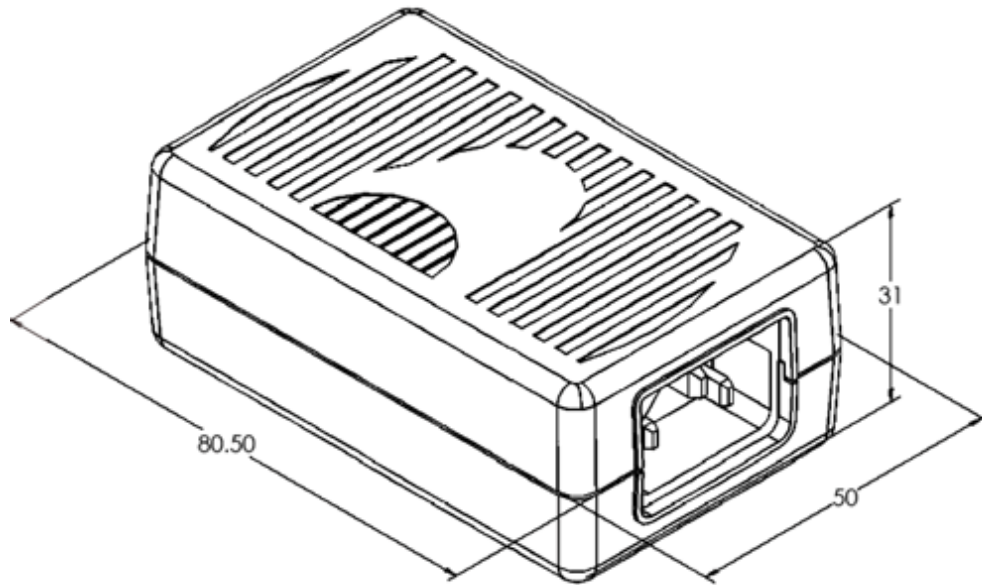

Delivering leading edge, innovative power solutions for more than **30** years....

Model:GT-41062-WWVV-T3

April 15, 2021

RATING TABLE

Model Number	Voltage	Amps(A)	Watts(W)	RFQ
GT-41062-1805-T3	5 V	3.6	18.00	RFQ
GT-41062-1806-T3	6 V	3	18.00	RFQ
GT-41062-1807-T3	7 V	2.57	17.99	RFQ
GT-41062-1809-T3	9 V	2	18.00	RFQ
GT-41062-0909-T3	9 V	1	9.00	RFQ
GT-41062-1812-T3	12 V	1.5	18.00	RFQ
GT-41062-1815-T3	15 V	1.2	18.00	RFQ
GT-41062-1818-T3	18 V	1	18.00	RFQ
GT-41062-1820-T3	20 V	0.9	18.00	RFQ
GT-41062-1824-T3	24 V	0.75	18.00	RFQ

SPECIFICATIONS

A) ELECTRICAL SPECIFICATIONS:

1. Input Voltage: Specified 90-264 Vac, Nameplate rated: 100-240Vac
2. Input Frequency: Specified 47-63 Hz, Nameplate rated 50-60Hz
3. Output Power (Rated): 18Watts max
4. Output Regulation: +/- 5% measured at the output connector
5. Line Voltage Regulation: +/- 1% typical measures at full load
6. Output Ripple (Vp-p): 1% or 150 mV whichever is greater measured at 20 MHz bandwidth with 0.1 uf ceramic capacitor in parallel with 10 uf electrolytic capacitor connected at the end of output connector at nominal line
7. Turn-On/Turn-Off Overshoot: 5% maximum, 1mS typical recovery time for 25% step load
8. Turn-On Delay: 1 second typical
09. Hold-Up Time: 8mS typical @ nominal input voltage & full load
10. Inrush Current: 30A typical @ 115Vac input ; 60A typical @ 230Vac input
11. Switching Frequency: 65 KHz typical

B) PROTECTION

1. Over-Voltage: Protected via zener diode across the output
2. Short Circuit: Electronically Protected, unit will recover upon removal of fault
3. Input Protection: Input line fusing

C) SAFETY

1. Dielectric Withstand Voltage: 4242Vdc from primary to secondary
2. Touch Current: <0.25mA @ 240Vac input voltage
3. Earth Leakage Current: <3.5mA @ 240Vac input voltage
4. ROHS 2: Complies with EU 2011/65/EU and China SJ/T 11363-2006
4. Earth continuity test:<0.1 Ohm or < 0.2 Ohm when with a non-detachable Power Supply cord, Class I Only

D) OTHER:

1. MTBF: 200,000 hours @ 25°C ambient temperature
2. Operating Temperature: 0°C to 40°C ambient temperature
3. Humidity: 0% to 90% relative humidity
4. Storage Temperature: -10°C to 80°C

E) ENCLOSURE

1. Upper Housing: High impact plastic, 94V0 polycarbonate, non-vented
2. Lower Housing: High impact plastic, 94V0 polycarbonate, non-vented
3. Size: 80.5* 50.0*31.0 mm +/-1.0

Delivering leading edge, innovative power solutions for more than **30** years....

Model:GT-41062-WWVV-T3

April 15, 2021

DERATING CURVE

Delivering leading edge, innovative power solutions for more than 30 years....

Model:GT-41062-WWVV-T3

April 15, 2021

INPUT CONFIGURATION

Description IEC 60320/C14 AC Inlet Connector, Class I, Earth Ground

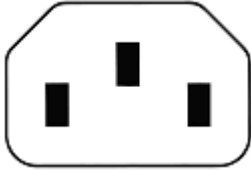

Mates with IEC 60320/C13 Plug

Optional Locking IEC60320 Receptacle and cord option available on some models by request.:

[Standard International IEC 320/C13 Cordsets](#)

Below are standard cordsets which are "not included" (unless stated above); these can be purchased separately or packaged with the power supply. Contact your Sales Engineer if the style required is not shown below. Many more available in different lengths, colors or cable material.

Stock Power Supply Cords

Part Number/ Link	Country	Plug	Termination	Length (mm)	(Ft)
3021457F701(R)	N. American (Type B)	NEMA 5-15P	IEC 320/C13	2150	7
1191068F0701(R)	N. American (Type B)	NEMA 5-15P Hospital	IEC 320/C13	2459	8
2194272M5701-T(R)	Argentina (Type I)	IRAM 2073	IEC 320/C13	2500	8
5502022M5701A(R)	Australian (Type I)	AS3112 / 3 PRONG	IEC 320/C13	2500	8
204B4272M5701(R)	Brazil (Type N)	BRAZIL	IEC 320/C13	2500	8
6023602M5701(R)	China (Type I)	CCC GR2099	IEC 320/C13	2500	8
G8014272M5701(R)	Danish (Type K)	AFSNIT SECTION 107-2-D1	IEC 320/C13	2500	8
23144272M5701-T(R)	Europe (Type E)	CEE 7/7	IEC 320/C13	2500	8
205IN4272M5701(R)	India (Type D)	India IS 1293 (also known as IA16A3 or BS546)	IEC 320/C13	2500	8
208IN4272M5701(R)	India (Type M)	India IS 1293 (also known as IA16A3 or BS546)	IEC320/C13	2500	8
377C4272M5701(R)	Israel (Type H)	ISL 377C	IEC 320/C13	2500	8
23024272M5701(R)	Italy (Type L)	CEI 23-16/VII	IEC 320/C13	2500	8
3003339F701(R) [3x1.25mm2]	Japan (Type B)	JIS 8303 / 3 PINS	IEC 320/C13	2500	8

PROPRIETARY INFORMATION

PROPRIETARY OF GLOBTEK, INC. ANY REPRODUCTION, DISCLOSURE OR USE OF THIS DRAWING, IN WHOLE OR IN PART, IS HEREBY PROHIBITED EXCEPT AS SPECIFIED IN WRITING BY GLOBTEK, INC.

<https://en.globtek.com/datasheet/id/a003000007P7Z3>

Delivering leading edge, innovative power solutions for more than **30** years....

Model:GT-41062-WWVV-T3

April 15, 2021

3003068F2701-HK(R) [3 x 2.0mm2]					
302J115J6F0701J(R)	Japan / North America (Type B – 12A)	JIS 8303 / 3 PINS and NEMA 5-15P (PSE and UL/CUL appr)	IEC 320/C13	1830	6
302J104J6F0701J(R)	Japan / North America (Type B – 15A)	JIS 8303 / 3 PINS and NEMA 5-15P (PSE and UL/CUL appr)	IEC 320/C13	1830	6
2313K3432M5701(R)	Korea (Type F)	KS C 8305	IEC 320/C13	2500	8
5804272M5701(R)	Russia (Type F)	GOST 7396	IEC 320/C13	2500	8
2084272M5701(R)	South Africa (Type M)	South Africa SABS164-1 (16A type)	IEC 320/C13	2500	8
23214272M5701(R)	Switzerland (Type J)	SEV 1011	IEC 320/C13	2500	8
3003322M5701(R)	Taiwan (Type B)	BSMI	IEC 320/C13	2500	8
PZ0800100-2M5BK13H(R)	UK, Hong Kong, Singapore, Gulf States (Type G)	BS 1363A	IEC 320/C13	2500	8
7055002M5701A(R)	International	IEC 320 C14-C13	IEC 320/C13	2500	8

Delivering leading edge, innovative power solutions for more than 30 years....

Model:GT-41062-WWVV-T3

April 15, 2021

OUTPUT CONFIGURATION

Common output connector options:

 L Type (Coaxial
5.5x2.5mm plug)

 C Type (Coaxial
5.5x2.1mm plug)

 K Type (Coaxial
3.5x1.3mm plug)

 LL Type (5.5x2.5mm
Locking 760k type)

 CL Type (5.5x2.1mm
Locking S761k type)

 ML2 Type (Molex
housing 43025-0200)

 YL3 Type
(KPPX-3P)

YL4 Type (KPPX-4P)

 EJ1/2/3/4/5 (EIAJ
RC-5320A type
connectors)

 MSB Type (Micro
USB)

 USBC Type (USB
Type C)

 Inquire for custom
design

 For a comprehensive list of options, [click here](#)







Contact GlobTek for your specific requirements or custom solutions.

Delivering leading edge, innovative power solutions for more than **30** years....

Model:GT-41062-WWVV-T3

April 15, 2021









Approvals

Logo	Description
No Logo	CB Certificate IEC 60950-1:2005 (2nd Edition), Am 1: 2009, CB report IEC 60950-1:2005 (2nd Edition), Am 1: 2009 and EN 60950-1:2006 + Am 1:2010 + Am 11:2009 + Am 12:2011
No Logo Applicable	CB for IEC 62368-1:2014 (Second Edition) + A11:2017
	CCC to GB4943.1-2011; GB/T9254-2008 GB17625.1-2012, Tropical <2000
	CE Mark: tested to comply with EN55022:2006/A1:2007 Class B, EN610003-2, EN610003-3 including EN61000-4-2, EN61000-4-3, EN61000-4-4, EN61000-4-5, EN61000-4-6N EN61000-4-11; EMI: Complies with EN55011 CLASS B and FCC Part 15B - On label or Molded in case
	CHINA SJ/T 11364-2014, China RoHS Chart: http://en.globtek.com/globtek-rohs.php
Conforms to UL STD. 62368-1 Certified to CSA STD C22.2 NO.62368-1	Conforms to UL STD. 62368-1 Certified to CSA STD C22.2 NO.62368-1
	UL60950-1, cULus to UL 60950-1, 1st Edition, 2007-10-31 and CSA C22.2 No. 60950-1-03, 1st Edition, 2006-07
	Certification # TC RU AR46.B.75423 Custom Union of Russia, Belarus and Kazakhstan
	Indoor Use Only - Mark is on the label or Molded in the case
IP40	Ingress Protection: ?IP40 to IEC60529:2001 Protection against granular foreign bodies

Delivering leading edge, innovative power solutions for more than 30 years....

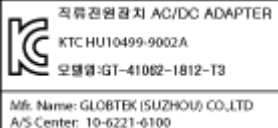
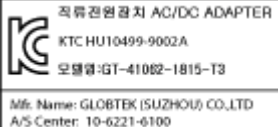
Model:GT-41062-WWVV-T3









April 15, 2021

 DC-E-G71-001.1	IRAM certificate DC-E-G71-001.1 to IEC 60950 + A1:2009
 GlobTek, Inc.	JAPAN TUV R-PSE, Cert. No. JD 50471561.pdf, to J62368-1(H30) , J55032(H29), J3000(H25) ,[15V?30V]. Please reference the following website for PSE regulations: http://en.globtek.com/importing-ite-and-medical-power-supplies-ac-adaptors-to-japan/
 GlobTek, Inc.	JAPAN TUV R-PSE, Cert. No. JD 50471561, to J62368-1(H30) , J55032(H29), J3000(H25) ,[15V or less]. Please reference the following website for PSE regulations: http://en.globtek.com/importing-ite-and-medical-power-supplies-ac-adaptors-to-japan/
 KTC HU10499-9002A 모델명:GT-41062-1809-T3 Mfg. Name: GLOBTEK (SUZHOU) CO.,LTD A/S Center: 10-6221-6100	Korea KET KC Mark GT-41062-1809-T3 HU10499-9002A (9V Only)
 KTC HU10499-9002A 모델명:GT-41062-1812-T3 Mfg. Name: GLOBTEK (SUZHOU) CO.,LTD A/S Center: 10-6221-6100	Korea KET KC Mark GT-41062-1812-T3 HU10499-9002A (12V Only)
 KTC HU10499-9002A 모델명:GT-41062-1815-T3 Mfg. Name: GLOBTEK (SUZHOU) CO.,LTD A/S Center: 10-6221-6100	Korea KET KC Mark GT-41062-1815-T3 HU10499-9002A (15V Only)
 KTC HU10499-9001A 모델명:GT-41062-1824-T3 Mfg. Name: GLOBTEK (SUZHOU) CO.,LTD A/S Center: 10-6221-6100	Korea KET KC Mark GT-41062-1824-T3 HU10499-9001A (18V, 20V, 24V Only)
EFFICIENCY LEVEL 	Efficiency: complies to section 301 of Energy Independence and Security Act (EISA) complies with Energy Star tier 2 (North America), ECP tier 2 (China), MEPS tier 2 (Australia), Code of Conduct (Europe)
EFFICIENCY LEVEL 	Efficiency: complies to section 301 of Energy Independence and Security Act (EISA) complies with Energy Star tier 2 (North America), ECP tier 2 (China), MEPS tier 2 (Australia), Code of Conduct (Europe)... NOTE: 24V & 1830 mm 18 - 20awg o/p cord only
LPS	Limited Power Source 60950

Delivering leading edge, innovative power solutions for more than 30 years....

Model:GT-41062-WWVV-T3

April 15, 2021

	Natural Resources Canada (NRCAN): CSA Standard C381.1-08, QSP NRCAN EEV1191; http://shop.csa.ca/en/canada/energy-efficiency/canca-c3811-08/invt/27024802008
 GlobTek, Inc.	JAPAN TUV Rheinland-PSE GlobTek Inc to J60950-1(H26) , J55022(H22),J3000(H25).Please follow the procedure listed in the following link for proper import to Japan: http://en.globtek.com/importing-to-japan.php .
	Australia and New Zealand Regulatory Compliance, Mark (http://rcm.standards.org.au/rcmfaq/rcmfaq.htm
RoHS	Specifications of directive 2011/65/EU Annex VI (ROHS-2) with amendment 2015/863-EU (ROHS-3) http://www.ce-mark.com/Rohs%20final.pdf
 IEC/EN60950-1	SIQ Mark License Certificate EN 60950-1:2006 + Am 1:2010+ Am 11:2009 + Am 12:2011
	UKCA Certification
 10276	Ukraine UKRSepro (Document: www.globtek.com/html/iso_certificates/GT_Ukraine.pdf)
	Japan: Voluntary Control Council for Interference (VCCI)
	WEEE: Complies with EU 2012/19/EU (http://ec.europa.eu/environment/waste/weee/index_en.htm) Mark is on the label or Molded in the case