

Delivering leading edge, innovative power solutions for more than **30** years....

Model:GTM21089-W2E

April 15, 2021

GTM21089-W2E

Information

Model Number

GTM21089-W2E

Description

GTM21089-W2E, Medical Power Supply, Wall Plug-in, Regulated Switchmode AC-DC Power Supply AC Adaptor, , Input Rating: 100-240V~, 50-60 Hz, European CEE 7/16 configuration:EN 50075 Europlug 2 PIN, Output Rating: 18 Watts, Power rating with convection cooling (W) , 3.3-24V in 0.1V increments, Approvals: EAC; VCCI; Book 60601; CE; Double Insulation; RoHS; WEEE; Ukraine; China RoHS;

Model Picture



Agency Documents

<http://www.globtek.info/certs/GTM21089/>

CE EC-Declaration

https://www.globtek.com/pdf/ec_declaration/a0O3000000A1YnyEAF

RoHS/RoHS2 Declaration

https://www.globtek.com/pdf/rohs_cert/a0O3000000A1YnyEAF

REACH Declaration

https://www.globtek.com/pdf/iso_certificates/REACH.pdf

Conflict Minerals Declaration

<https://www.globtek.com/pdf/conflict-minerals.pdf>

Delivering leading edge, innovative power solutions for more than **30** years....

Model:GTM21089-W2E

April 15, 2021

MODEL PARAMETERS

Type	Wall Plug-in
Technology	Regulated Switchmode AC-DC Power Supply AC Adaptor
Category	Medical Power Supply
Input Voltage	100-240V~, 50-60 Hz
I/P Amps (A)	0.5A
Wattage (W)	18.0
Vout Range (V)	3.3-24
Efficiency Level	Meets/Exceeds for Medical
Ingress Protection	
Size (mm)	87*47*32

PROPRIETARY INFORMATION

PROPRIETARY OF GLOBTEK, INC. ANY REPRODUCTION, DISCLOSURE OR USE OF THIS DRAWING, IN WHOLE OR IN PART, IS HEREBY PROHIBITED EXCEPT AS SPECIFIED IN WRITING BY GLOBTEK, INC.

<https://en.globtek.com/datasheet/id/a003000000A1Yny>

Delivering leading edge, innovative power solutions for more than 30 years....

Model:GTM21089-W2E

April 15, 2021

ENCLOSURE

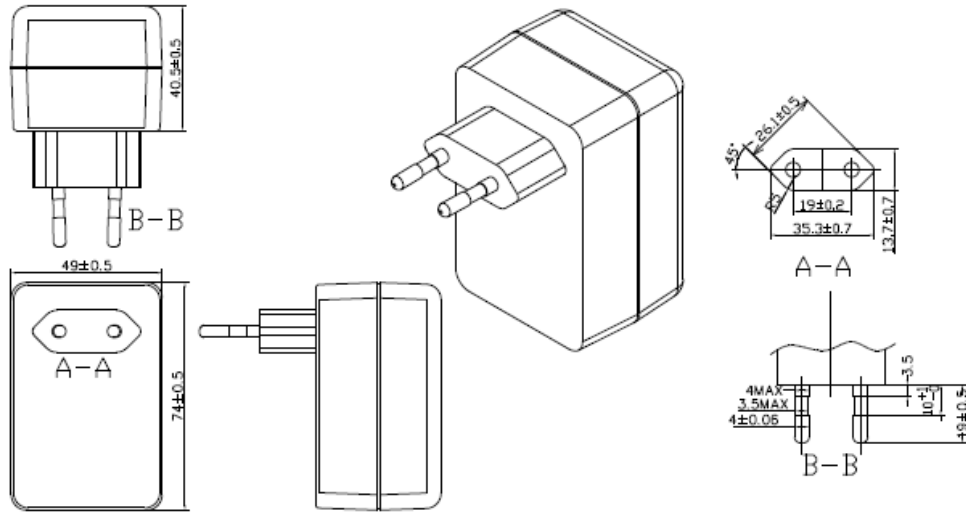

Delivering leading edge, innovative power solutions for more than **30** years....

Model:GTM21089-W2E

April 15, 2021

RATING TABLE

Model Number	Voltage	Amps(A)	Watts(W)	RFQ
GTM21089-0903-W2E	3.3 V	2.6	8.58	RFQ
GTM21089-1305-W2E	5 V	2.6	13.00	RFQ
GTM21089-1506-W2E	6 V	2.5	15.00	RFQ
GTM21089-1509-W2E	9 V	1.7	15.30	RFQ
GTM21089-1512-W2E	12 V	1.25	15.00	RFQ
GTM21089-1815-W2E	15 V	1.2	18.00	RFQ
GTM21089-1818-W2E	18 V	1	18.00	RFQ
GTM21089-1824-W2E	24 V	0.75	18.00	RFQ
GTM21089-1848-12.0-W2E	36 V	0.5	18.00	RFQ
GTM21089-1948-W2E	48 V	0.39	18.72	RFQ

Delivering leading edge, innovative power solutions for more than 30 years....

Model:GTM21089-W2E

April 15, 2021

SPECIFICATIONS

A) ELECTRICAL SPECIFICATIONS:

01. Input Voltage: Specified 90-264 Vac, Nameplate rated: 100-240Vac
02. Input Frequency: Specified 47-63 Hz, Nameplate rated 50-60Hz
03. Output Regulation: +/- 5% measured at the output connector, no minimum load required
04. Line Voltage Regulation: +/- 1% typical measured at full load
05. Output Ripple (Vp-p): 1% or 100 mV whichever is greater, measured at 20 MHz bandwidth with 0.1 uf ceramic capacitor in parallel with a low impedance 47 uf electrolytic capacitor connected at the end of the output connector
06. Turn-ON/OFF: 5% maximum, 1 mS typical recovery time for 25% step load
07. Turn-ON Delay: 1 Sec, typical
08. Hold-Up Time: 10 mS typical @ nominal input voltage and full load
09. Inrush Current: 30A maximum cold start @ 240Vac input
10. Switching Frequency: 100 KHz typical, varies with line and load
11. Efficiency: 75% typical at nominal input and full load

B) PROTECTION

01. Over-Voltage: Limited via crowbar method
02. Short Circuit: Momentary short circuit protected with auto recovery upon removal of short
03. Leakage Current: N/A for Class II units, there is no PE Ground pin, so Earth Leakage current is not measured
04. Touch Current: Maximum allowed values: 100uA NC(Normal condition) 500uA SFC(single fault condition)
05. Over-load: Hiccup with auto recovery
06. Input Protection: Input line and neutral fusing

C) SAFETY

01. Dielectric Withstand Voltage: 5656vdc from primary to secondary
02. Type of protection against electric shock: class II
03. Degree of protection against electric shock: not classified (no applied part)
04. Degree of protection Against ingress of water: IPX0 (ordinary)
05. Degree of safety of application in the presence of flammable anesthetic: not evaluated Mode of operation: continuous
06. Earth Leakage Current: <100 uA at 264Vac input voltage

D) OTHER:

01. MTBF: 200,000 Hours @ 25°C ambient temperature
02. Operating Temperature: 0°C to 40°C ambient temperature
03. Storage Temperature: -10°C to 80°C
04. Humidity: 0% to 90% relative humidity
05. ROHS: COMPLIES WITH EU 2011/65/EU AND CHINA SJ/T 11363-2006

E) ENCLOSURE

1. Upper Housing: High impact plastic, 94V0 polycarbonate, non-vented
2. Lower Housing: High impact plastic, 94V0 polycarbonate, non-vented
3. Size: 74*49*40.5 ± 0.5 mm

PROPRIETARY INFORMATION

PROPRIETARY OF GLOBTEK, INC. ANY REPRODUCTION, DISCLOSURE OR USE OF THIS DRAWING, IN WHOLE OR IN PART, IS HEREBY PROHIBITED EXCEPT AS SPECIFIED IN WRITING BY GLOBTEK, INC.

<https://en.globtek.com/datasheet/id/a003000000A1Yny>

Delivering leading edge, innovative power solutions for more than **30** years....

Model:GTM21089-W2E

April 15, 2021

DERATING CURVE

Model:GTM21089-W2E

April 15, 2021

INPUT CONFIGURATION

 Description European CEE 7/16 configuration:EN 50075 Europlug 2 PIN

The prongs of the Europlug are 19 mm long. They consist of a 9 mm long conductive tip of 4 mm diameter with a rounded ending, followed by a 10 mm long flexible insulated shaft of not more than 3.8 mm diameter. The two prongs are not exactly parallel and converge slightly; their centres are 19 mm apart at the tip and 18.6 mm apart at the base. The elasticity of the converging prongs provides sufficient contact force for the Europlug's current rating with a variety of socket-hole arrangements. The entire plug is 35.3 mm wide and 13.7 mm high, and must not exceed these dimensions within 18 mm behind its front plane (this allows for the recesses on many European socket types). The left and right side of the plug are formed by surfaces that are at 45° relative to the horizontal plan.

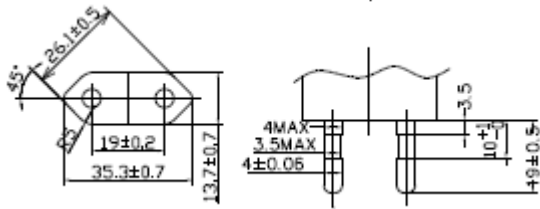

Delivering leading edge, innovative power solutions for more than 30 years....

Model:GTM21089-W2E

April 15, 2021

OUTPUT CONFIGURATION

Common output connector options:

 L Type (Coaxial
5.5x2.5mm plug)

 C Type (Coaxial
5.5x2.1mm plug)

 K Type (Coaxial
3.5x1.3mm plug)

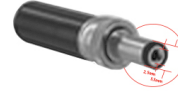
 LL Type (5.5x2.5mm
Locking 760k type)

 CL Type (5.5x2.1mm
Locking S761k type)

 ML2 Type (Molex
housing 43025-0200)

 YL3 Type
(KPPX-3P)

YL4 Type (KPPX-4P)

 EJ1/2/3/4/5 (EIAJ
RC-5320A type
connectors)

 MSB Type (Micro
USB)

 USBC Type (USB
Type C)

 Inquire for custom
design

 For a comprehensive list of options, [click here](#)











Contact GlobTek for your specific requirements or custom solutions.

Delivering leading edge, innovative power solutions for more than 30 years....

Model:GTM21089-W2E

April 15, 2021

Approvals

Logo	Description
	Attention Mark / Refer to operating manual for operating and service instructions
	60601-1 3rd Operating Instructions
	CE Mark: tested to comply with EN61000-3-2, EN61000-3-3 and EN50082-1, including EN61000-4-2, EN61000-4-3, EN61000-4-4, EN61000-4-5, EN61000-4-6, EN61000-4-8, EN61000-4-11, EN61001-1-2-2007 EMI: Complies with EN55011 CLASS B and FCC Part 15 B
	CHINA SJ/T 11364-2014, China RoHS Chart: http://en.globtek.com/globtek-rohs.php
	
	Certification # TC RU AR46.B.75423 Custom Union of Russia, Belarus and Kazakhstan
	Indoor Use Only - Mark is on the label or Molded in the case
RoHS	Specifications of directive 2011/65/EU Annex VI (ROHS-2) with amendment 2015/863-EU (ROHS-3) http://www.ce-mark.com/Rohs%20final.pdf
 10276	Ukraine UKRSePro (Document: www.globtek.com/html/iso_certificates/GT_Ukraine.pdf)
	Japan: Voluntary Control Council for Interference (VCCI)
	WEEE: Complies with EU 2012/19/EU (http://ec.europa.eu/environment/waste/weee/index_en.htm) Mark is on the label or Molded in the case