

Delivering leading edge, innovative power solutions for more than **30** years....

Model:GTM961005P-100PD-USBCP-T2

October 7, 2022

GTM961005P-100PD-USBCP-T2

Information

Model Number	GTM961005P-100PD-USBCP-T2
Description	GTM961005P-100PD-USBCP-T2, USB Adaptive Power Source ICT/ITE/Medical Power supply, Desktop/External, Regulated Switchmode AC-DC Power Supply AC Adaptor, , Input Rating: 100-240V~, 50-60Hz, IEC 60320/C8 AC Inlet connector, Class II, Non-Earth Ground (aka "Figure-8"), Output Rating: 100 Watts, Power rating with convection cooling (W) , 3.3-21V in 0.1V increments, Approvals: CE; China RoHS; Morocco; EAC; Ukraine; WEEE; VCCI; RoHS; Level VI; PSE; UKCA; Double Insulation;

Model Picture



Agency Documents

CE EC-Declaration	https://www.globtek.com/pdf/ec_declaration/a003a00000NHUPLEA5
RoHS/RoHS2 Declaration	https://www.globtek.com/pdf/rohs_cert/a003a00000NHUPLEA5
REACH Declaration	https://www.globtek.com/pdf/iso_certificates/REACH.pdf
Conflict Minerals Declaration	https://www.globtek.com/pdf/conflict-minerals.pdf

Delivering leading edge, innovative power solutions for more than **30** years....

Model:GTM961005P-100PD-USBCP-T2

October 7, 2022

MODEL PARAMETERS

Type	Desktop/External
Technology	Regulated Switchmode AC-DC Power Supply AC Adaptor
Category	USB Adaptive Power Source ICT/ITE/Medical Power supply
Input Voltage	100-240V~, 50-60Hz
I/P Amps (A)	1.5A
Wattage (W)	100.0
Vout Range (V)	3.3-21
Efficiency Level	USA DOE Level VI / Eco-design Directive 2009/125/EC, (EU) 2019/1782
Ingress Protection	IP41
Size (mm)	149.3 x 62.8 x 34.0 +/-1.0

Delivering leading edge, innovative power solutions for more than 30 years....

Model:GTM961005P-100PD-USBCP-T2

October 7, 2022

ENCLOSURE

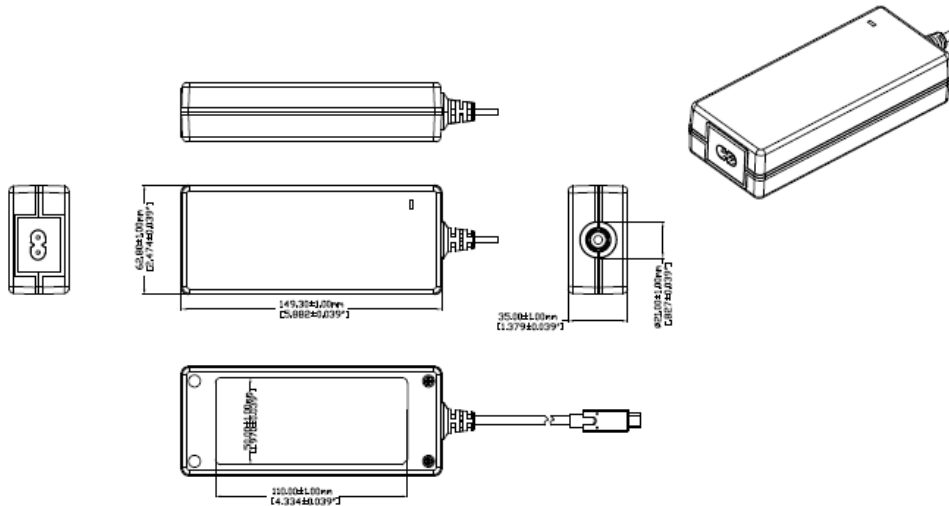

Delivering leading edge, innovative power solutions for more than **30** years....

Model:GTM961005P-100PD-USBCP-T2

October 7, 2022

RATING TABLE

Model Number	Voltage	Amps(A)	Watts(W)	RFQ
GTM961005P-100PD-USBCP-T2	V			RFQ

Delivering leading edge, innovative power solutions for more than 30 years....

Model:GTM961005P-100PD-USBCP-T2

October 7, 2022

SPECIFICATIONS

USB Power Delivery Capabilities

Protocol supported:	USB Power Delivery (PD) 2.0/3.0 + PPS
Advertised Power Data Objects (PDOs):	5V, 9V, 12V, 15V, 15.1V, 20V, PPS (3.3 - 21V)
Note 1:	Custom fixed PDOs available upon request. PDO1 must be 5V. PDO2 through PDO7 may be set to any custom voltage from 3.3V to 21V, with a step size of 100mV.
Note 2:	In critical applications, the use of a non-authorized USB PD power adapter may pose a substantial risk. The power adapter's identity may be checked and validated prior to PD contract negotiation by using USB PD Vendor Defined Messages (VDMs). Please see our article Product Security and Risk Mitigation for USB Power Delivery (PD) Based Systems for additional information.

Input

Input Voltage:	Specified: 85-264VAC, Nameplate: 100-240VAC 100% rated load current for 85-264VAC 100% rated load current for 110-370VDC
Input Frequency:	Specified: 47-63Hz, Nameplate: 50-60Hz
No Load Input Power:	< 150mW @ 230VAC (EU CoC Tier 2 compliant)
Inrush Current:	60A @ 115VAC, 120A @ 230VAC typ. (at peak of AC line, cold start)
Efficiency:	DoE Efficiency Level VI and CoC Tier 2 compliant (tested according to DoE 10 CFR Part 430, Subpart B, Appendix Z)

Output

Turn-on Delay:	< 1 second @ 115VAC and full load
Output Regulation	± 4% max. (measured at the end of a 1m long output cord)
Line Regulation:	± 0.5% typ. (measured at the end of a 1m long output cord)
Ripple:	75mV max. (0 - 100% load, using a 47µF low-ESR electrolytic cap + 0.1µF ceramic cap, measured @ 20MHz BW, at the output connector)
Transient Response:	5% ΔV max. ; 1ms recovery time max. (for 25% - 75% step, Vout > 9V) 10% ΔV max. ; 1ms recovery time max. (for 25% - 75% step, Vout ≤ 9V)
Hold-up Time:	20ms typ. (100VAC, 100% load) 25ms min. (100VAC, 75% load)
Power Indicator:	Green LED

Protections

Input Protection:	MOV transient suppressor, input line fusing Level 1: 110-130%, Auto-recovery, adaptive to selected PDO
-------------------	---

Delivering leading edge, innovative power solutions for more than 30 years....

Model:GTM961005P-100PD-USBCP-T2

October 7, 2022

Over-Voltage Protection:	Level 2: 24-28V, Latched off, cycle AC to reset
Over-Current Protection:	110-130%, Auto-recovery, adaptive to selected PDO
Short-Circuit Protection:	Auto-recovery
Over-Temperature Protection:	Level 1: Auto-recovery, temperature readable via USB PD 3.0 Extended Messages Level 2: Latched off, cycle AC to reset

Environmental

MTBF:	1,500,000 hours @ 25°C ambient, full load (Telcordia SR-332, Issue 3)
Operating Temperature:	-10°C to 40°C (full load)
Storage Temperature:	-40°C to 80°C
Humidity:	0% to 95% relative humidity, non-condensing
Altitude	5000m
Cooling:	Convection
RoHS:	Complies with EU 2011/65/EU and China SJ/T 11363-2006

Safety

Applicable Standards:	Medical: IEC60601-1(3.1e) ITE/ICT: IEC62368-1 (3e)
Dielectric Withstand Voltage:	4000VAC or 5656VDC from input to output 10mA, 1 minute
Output Leakage Current:	Class II "F1" (two-conductor input): NC: 100µA max. SFC: 150µA max. Class II "F2" (functional earth (FE)): NC: 10µA max. SFC: 100µA max. Class I (earthed output): NC: 5µA max. SFC: 100µA max.
Earth Leakage Current	300µA max. NC & SFC (N/A for 2-conductor input models)
Means of Protection:	2 x MOPP
Output Isolation Options:	-T2 suffix: Class II (two-conductor input) -T3 suffix: Class II (with functional earth (FE)) ~or~ Class I (earth wire connected directly to output negative)
Note 3:	Review output isolation options with our article: PSU Isolation and Identify

EMC

Applicable Standards:	Medical: IEC60601-1-2 (4e) Emissions: EN55032, IEC61000-6-3, IEC61000-6-4
-----------------------	--

PROPRIETARY INFORMATION

PROPRIETARY OF GLOBTEK, INC. ANY REPRODUCTION, DISCLOSURE OR USE OF THIS DRAWING, IN WHOLE OR IN PART, IS HEREBY PROHIBITED EXCEPT AS SPECIFIED IN WRITING BY GLOBTEK, INC.

<https://www.globtek.com/datasheet/w152642>

Delivering leading edge, innovative power solutions for more than 30 years....

Model:GTM961005P-100PD-USBCP-T2

October 7, 2022

	Immunity: EN55024, IEC61000-6-1 (4e), IEC61000-6-2 (4e)
Conducted Emissions:	EN55032, Class B (with resistive load)
Radiated Emissions:	EN55032, Class B (with resistive load)
Harmonic Current Voltage Distortion:	IEC61000-3-2, Class A
Voltage Fluctuations/Flicker:	IEC61000-3-3
Electrostatic Discharge (ESD) Immunity:	IEC61000-4-2, 10KV contact discharge, 18KV air discharge, Criterion A
Radiated RF Immunity:	IEC61000-4-3, 10V/m @ 80-1000MHz, 3V/m @ 1-2.7GHz, 80% 1KHz AM, Criterion A
EFT/Burst Immunity:	IEC61000-4-4, 4KV/100KHz., Criterion A
Line Surge Immunity:	IEC61000-4-5, 2KV differential, 4KV common-mode, Criterion A
Conducted RF Immunity:	IEC61000-4-6, 10VRMS, 80% 1KHz AM, Criterion A
Voltage Dip Immunity:	IEC61000-4-11, Criterion B/C

Enclosure

Housing:	High impact plastic, 94V0 polycarbonate, non-vented
Markings:	Adhesive backed label or laser engraving

Prevention of Unauthorized Use

	In critical applications, the use of a non-authorized USB PD power adapter may pose a substantial risk to system safety or performance.
USB Power Delivery:	The power adapter's identity may be checked and validated prior to PD contract negotiation by use of USB PD Vendor Defined Messages (VDMs). The power adapter will respond to a USB PD "Discover Identity" VDM with 0x4754 in the "ProductID" field. Additionally, a non-standard 15.1V PDO is included. Host systems may be designed to reject a power adapter which does not contain a 15.1V PDO.
Note 5:	These measures do not ensure a secure implementation, and are only suggested as a method of risk mitigation.
Note 6:	Please see our article Product Security and Risk Mitigation for USB Power Delivery (PD) Based Systems for additional information.

Special Options

Non-standard - Contact GlobTek

1. Custom housing and output cord colors
2. Custom fixed output cord length (1m, 2m, 3m lengths)
3. Custom markings and marking methods
4. Custom USB PD PDOs: Output voltages selectable between 3.3V and 21V, in 100mV increments

Delivering leading edge, innovative power solutions for more than 30 years....

Model:GTM961005P-100PD-USBCP-T2

October 7, 2022

DERATING CURVE

TYPICAL EXTERNAL POWER SUPPLY DERATING CURVE

(GTM96900 LPS PRODUCTS)

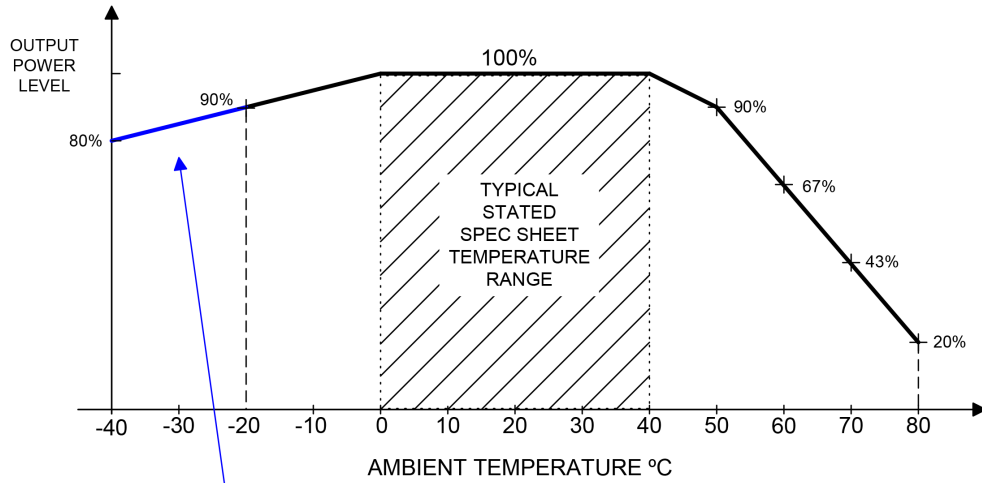

Blue Line represents special/optional Low Temperature, High Performance Construction

Delivering leading edge, innovative power solutions for more than 30 years....

Model:GTM961005P-100PD-USBCP-T2

October 7, 2022

INPUT CONFIGURATION

Description IEC 60320/C8 AC Inlet connector, Class II, Non-Earth Ground (aka "Figure-8")

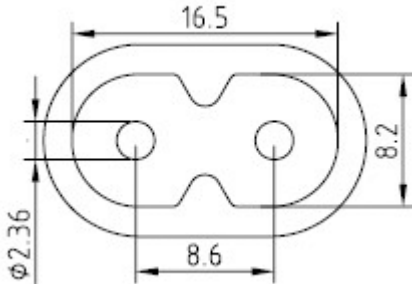

Mates with IEC 60320/C7 Plug

Below are standard cordsets which are "not included" (unless stated above); these may be purchased separately or packaged with the power supply. Please contact your Sales Engineer if the style required is not shown below. Many more available in different lengths, colors or cable material.

Standard International IEC 320/C7 Cordsets

Part Number	Type	Standard	Connector	Length (mm)	Length (feet)
2094112M703(R)	Argentina (Type I)	IRAM 2063	IEC 320/C7	2000	7
5014112M703A(R)	Australian (Type I)	AS 3112	IEC 320/C7	2000	7
207B4111M8703(R)	Brazil (Type N)	NBR14136	IEC 320/C7	1800	6
4533501M8703(R)	China (Type A)	GB 2099.1	IEC 320/C7	1830	6
2074112M703A(R)	European (Type C)	CEE 7/16	IEC 320/C7	2000	7
2074112M703AEUSA(R)	European/South Africa Combo(Type C)	CEE 7/16	IEC 320/C7	2000	7
2084111M8703B(R)	India (Type D)	IS 1293	IEC 320/C7	1800	6
451J3401M8703(R)	Japan (Type A)	JIS 8303	IEC 320/C7	1830	6
2044112M703A(R)	Korea (Type C)	KS C8305	IEC 320/C7	2000	7
4511116F703A(R)	North America (Type A)	NEMA 1-15P	IEC 320/C7	1830	6
2084111M8703(R)	South Africa (Type M)	BS 546	IEC320/C7	1830	6
4033401M8703A(R)	Taiwan (Type A)	CNS690	IEC 320/C7	1830	6
6104112M703A(R)	UK, Hong Kong, Singapore, Gulf States (Type G)	BS1363	IEC 320/C7	2000	7

PROPRIETARY INFORMATION

PROPRIETARY OF GLOBTEK, INC. ANY REPRODUCTION, DISCLOSURE OR USE OF THIS DRAWING, IN WHOLE OR IN PART, IS HEREBY PROHIBITED EXCEPT AS SPECIFIED IN WRITING BY GLOBTEK, INC.

<https://www.globtek.com/datasheet/w152642>

Delivering leading edge, innovative power solutions for more than **30** years....

Model:GTM961005P-100PD-USBCP-T2

October 7, 2022

451G1116F703A(R)	Gulf States (Kuwait, Bahrain, Oman, Qatar, Saudi Arabia, Yemen and the United Arab Emirates (UAE)(Type A)	Nema 1-15P	IEC320/C71830	6
6303742M5703(R)	Thailand (Type C)	TIS 166-2549	IEC320/C72500	8

Delivering leading edge, innovative power solutions for more than 30 years....

Model:GTM961005P-100PD-USBCP-T2

October 7, 2022

OUTPUT CONFIGURATION

Common output connector options:

 L Type (Coaxial
5.5x2.5mm plug)

 C Type (Coaxial
5.5x2.1mm plug)

 K Type (Coaxial
3.5x1.3mm plug)

 LL Type (5.5x2.5mm
Locking 760k type)

 CL Type (5.5x2.1mm
Locking S761k type)

 ML2 Type (Molex
housing 43025-0200)

 YL3 Type
(KPPX-3P)

YL4 Type (KPPX-4P)

 EJ1/2/3/4/5 (EIAJ
RC-5320A type
connectors)

 MSB Type (Micro
USB)

 USBC Type (USB
Type C)

 Inquire for custom
design

 For a comprehensive list of options, [click here](#)









Contact GlobTek for your specific requirements or custom solutions.

Delivering leading edge, innovative power solutions for more than **30** years....

Model:GTM961005P-100PD-USBCP-T2

October 7, 2022



Approvals

Logo	Description
	CE Certification
	CHINA SJ/T 11364-2014, China RoHS Chart: http://en.globtek.com/globtek-rohs.php
	
	Declaration ДС № EAЭC N RU Д-US.KA01.B.10453_19 Custom Union of Russia, Belarus and Kazakhstan http://www.globtek.com/redirect/?loc=gost-certificate-eac-declaration
 GlobTek, Inc.	JAPAN TUV R-PSE, Cert. No. JD 50469658, to J62368-1(H30) , J55032(H29),J3000(H25)[15V or less]. Please reference the following website for guidelines on PSE regulations: http://en.globtek.com/importing-ite-and-medical-power-supplies-ac-adaptors-to-japan/
	Efficiency: complies to section 301 of Energy Independence and Security Act (EISA) complies with Energy Star tier 2 (North America), ECP tier 2 (China), MEPS tier 2 (Australia), Code of Conduct (Europe)
	Morocco SDoC declaration http://www.globtek.info/certs/Morocco%20SDoC%20Declaration/
RoHS	Specifications of directive 2011/65/EU Annex VI (ROHS-2) with amendment 2015/863-EU (ROHS-3) http://www.ce-mark.com/Rohs%20final.pdf
	UKCA Certification

Delivering leading edge, innovative power solutions for more than **30** years....

Model:GTM961005P-100PD-USBCP-T2

October 7, 2022

 10276	Ukraine UKRSeprO (Document: www.globtek.com/html/iso_certificates/GT_Ukraine.pdf
	Japan: Voluntary Control Council for Interference (VCCI)
	WEEE: Complies with EU 2012/19/EU (http://ec.europa.eu/environment/waste/weee/index_en.htm) Mark is on the label or Molded in the case