

Delivering leading edge, innovative power solutions for more than 30 years....

Model:GTM41080-18VV-F (PCB Mounted)

October 7, 2022

## GTM41080-18VV-F (PCB Mounted)

### Information

#### Model Number

GTM41080-18VV-F (PCB Mounted)

#### Description

GTM41080-18VV-F (PCB Mounted), Medical Power Supply, 60601-1-4th Ed. , Open Frame/Internal, Regulated Switchmode AC-DC Power Supply AC Adaptor, , Input Rating: 100-240V~, 50-60 Hz, Molex 09-65-2058 5 Position Header Pin 1: Earth, Pin 2: Removed, PIN 3: Neutral, Pin 4: removed, Pin 5: Line, Output Rating: 18 Watts, Power rating with convection cooling (W) , (5-48 Class I)V in 0.1V increments, Approvals: UKCA; Fuse 60335; CB EN/IEC 60335-1; CB EN/IEC 60335-1; CB 60601-1; CE; cETLus ES60601; cETLus 60601-1 3rd; China RoHS; Class I; Fuse 60335; Level V; NEMKO EN/IEC 60335-1; NOM (5V only); RoHS; S-Mark IEC/EN 60601-1; WEEE; CE; CE; CB 60601-1; CE;

#### Model Picture

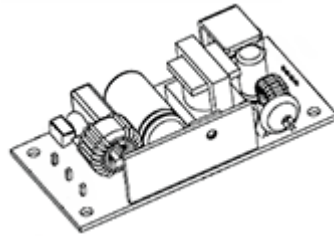

#### Agency Documents

<http://www.globtek.info/certs/GTM41080/>

#### CE EC-Declaration

[https://www.globtek.com/pdf/ec\\_declaration/a00a000000FiRstEAF](https://www.globtek.com/pdf/ec_declaration/a00a000000FiRstEAF)

#### RoHS/RoHS2 Declaration

[https://www.globtek.com/pdf/rohs\\_cert/a00a000000FiRstEAF](https://www.globtek.com/pdf/rohs_cert/a00a000000FiRstEAF)

#### REACH Declaration

[https://www.globtek.com/pdf/iso\\_certificates/REACH.pdf](https://www.globtek.com/pdf/iso_certificates/REACH.pdf)

#### Conflict Minerals Declaration

<https://www.globtek.com/pdf/conflict-minerals.pdf>

Delivering leading edge, innovative power solutions for more than **30** years....

Model:GTM41080-18VV-F (PCB Mounted)

October 7, 2022

**MODEL PARAMETERS**

Type	Open Frame/Internal
Technology	Regulated Switchmode AC-DC Power Supply AC Adaptor
Category	Medical Power Supply
Input Voltage	100-240V~, 50-60 Hz
I/P Amps (A)	0.6A
Wattage (W)	18.0
Vout Range (V)	(5-48 Class I)
Efficiency Level	V
Ingress Protection	IPX0
Size (mm)	84.5*41.5*21.6

Delivering leading edge, innovative power solutions for more than 30 years....

Model:GTM41080-18VV-F (PCB Mounted)

October 7, 2022

# ENCLOSURE

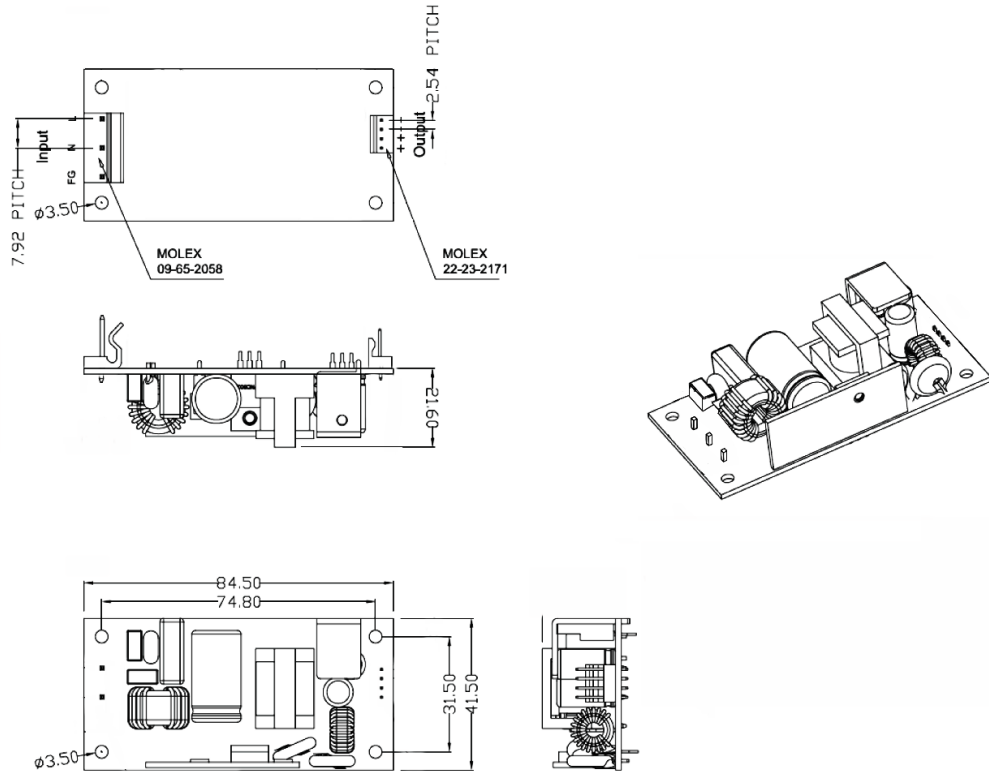

Delivering leading edge, innovative power solutions for more than **30** years....

Model:GTM41080-18VV-F (PCB Mounted)

October 7, 2022

## RATING TABLE

Model Number	Voltage	Amps(A)	Watts(W)	RFQ
--------------	---------	---------	----------	-----

Delivering leading edge, innovative power solutions for more than 30 years....

Model:GTM41080-18VV-F (PCB Mounted)

October 7, 2022

## SPECIFICATIONS

### A) ELECTRICAL SPECIFICATIONS:

01. Input Voltage: 100-240 Vac
02. Input Frequency: 47 - 63 Hz
03. Output Regulation: +/- 5% measured at the output connector
04. Line Voltage Regulation: +/- 1% typical measured at full load
05. Output Ripple (Vp-p): +/-1% or 150 mV whichever is greater, measured at 20 MHz bandwidth with 0.1 uf ceramic capacitor in parallel with 10 uf electrolytic capacitor connected at the end of the output connector at nominal line
06. Turn-ON/OFF Overshoot: 5% maximum, 1 mS typical recovery time for 25% to 50% step load
07. Turn-ON Delay: 3000 mS, maximum @ full load, nominal line
08. Hold-Up Time: 8 mS typical @ nominal input voltage and full load
09. Inrush Current: 30A maximum cold start @ 240Vac input
10. Switching Frequency: 65 KHz typical
11. Efficiency: Compliant with Worldwide Level V standards.
12. No Load Standby Power: <0.3 W

### B) PROTECTION

01. Over-Voltage: Electronically Protected Zener clamp across the output
02. Short Circuit: Electronically Protected unit will auto recover upon removal of fault
04. Input Protection: Input line and neutral fusing

### C) SAFETY

01. Protection class: Factory configured and labeled as Class I Functional Earth equipment. May be used as Class II equipment by physically removing(cutting) the Functional Earth terminal from the input connector (as provisioned by CB report). May be ordered as Class II with a 2 circuit input connector and double-box marking under an alternate ordering part number.
02. Dielectric Withstand Voltage: 5656Vdc from primary to secondary
03. Earth Leakage Current: <0.25 mA at 240Vac input voltage

### D) OTHER:

01. MTBF: 200,000 Hours @ 25°C ambient temperature
02. Operating Temperature: 0°C to 40°C ambient temperature
03. Humidity: 0% to 90% relative humidity
04. Storage Temperature: -10°C to 80°C
05. Cooling: Convection

### E) ENCLOSURE

01. Open Frame
02. Size: 84.5\*41.5\*21.6 mm +/-1.0 mm (3.3\*1.6\*0.9 inches)
03. Markings: Label

#### PROPRIETARY INFORMATION

PROPRIETARY OF GLOBTEK, INC. ANY REPRODUCTION, DISCLOSURE OR USE OF THIS DRAWING, IN WHOLE OR IN PART, IS HEREBY PROHIBITED EXCEPT AS SPECIFIED IN WRITING BY GLOBTEK, INC.

<https://www.globtek.com/datasheet/w70796>

Delivering leading edge, innovative power solutions for more than **30** years....

Model:GTM41080-18VV-F (PCB Mounted)

October 7, 2022

### DERATING CURVE

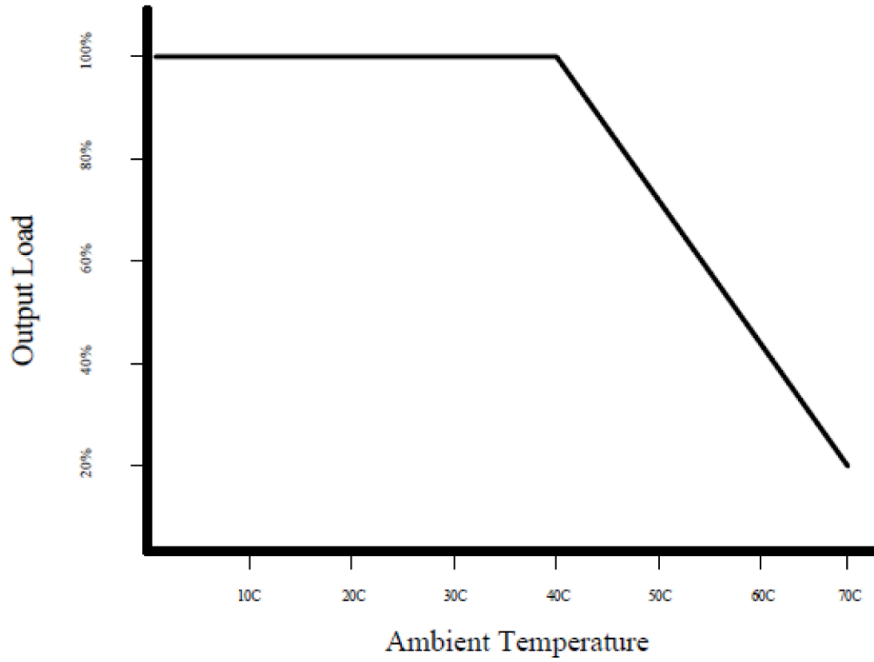

Delivering leading edge, innovative power solutions for more than 30 years....

Model:GTM41080-18VV-F (PCB Mounted)

October 7, 2022

### INPUT CONFIGURATION

Description Molex 09-65-2058 5 Position Header Pin 1: Earth, Pin 2: Removed, PIN 3: Neutral, Pin 4: removed, Pin 5: Line

Document: [http://www.molex.com/pdm\\_docs/sd/009652058\\_sd.pdf](http://www.molex.com/pdm_docs/sd/009652058_sd.pdf)

Catalog Page: [http://www.molex.com/molex/products/datasheet.jsp?part=active/0009652058\\_PCB\\_HEADERS.xml](http://www.molex.com/molex/products/datasheet.jsp?part=active/0009652058_PCB_HEADERS.xml)

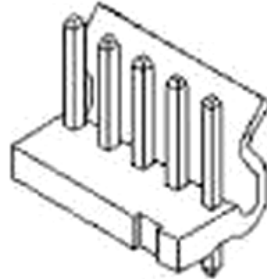
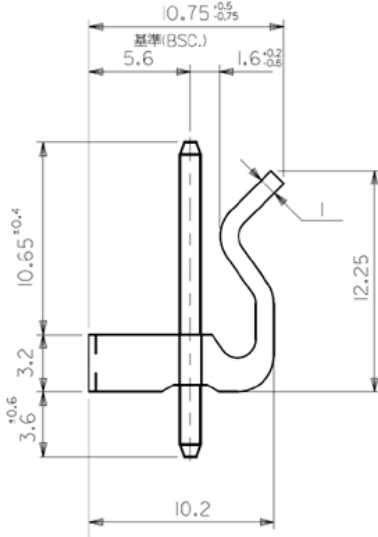

Mates With Part(s):







**5195 SPOX™ Crimp Housing, 5239 KK® Crimp Housing**

Delivering leading edge, innovative power solutions for more than 30 years....

Model:GTM41080-18VV-F (PCB Mounted)

October 7, 2022

## Approvals









Logo	Description
	Book 60335 up to 36 Volts
No Logo Applicable	CB to IEC 60601-1:2005 (Third Edition) + CORR. 1:2006 + CORR. 2:2007 + A1:2012 (or IEC 60601-1: 2012 reprint)
No Logo Applicable	CB to 60335-1:2010 (Fifth Edition) incl. Corr. 1:2010 and Corr. 2:2011 + A1:2013
No Logo Applicable	CB to 60335-1 5th Edition (Safety of Household and Similar Electrical Appliances, Part 1: General Requirements) CB Report/ Certificate IEC 60335-1:2010 Up to 36 volts only
No Logo Applicable	CB to 60601-1 3rd Edition 2xMOPP, CB Certificate: IEC 60601-1:2005, CB report: IEC 60601-1: 2005 + CORR. 1 (2006) + CORR. 2 (2007) and EN 60601-1:2006
	CE Certification CE Mark: tested to comply with EN 55032.2012+AC.2013 EN 61000-3-2.2014 EN 61000-3-3.2013 EN 60601-1-2.2015 EN 55024.2010
	CE Mark: tested to comply with EN 60601-1-2:2015 Medical electrical equipment Part 1-2: - Mark is on the label or Molded in the case
	CE Mark: tested to comply with EN 60601-1-2:2015 Medical electrical equipment Part 1-2: - Mark is on the label or Molded in the case
	CE Mark: tested to comply with EN 60601-1-2:2015 Medical electrical equipment Part 1-2: - Mark is on the label or Molded in the case
Conforms to ANSI/AAMI ES 60601-1:2005 Cert.to CAN/CSA Std. C22.2	cETLus ANSI_AAMI ES60601-1_2005
	cETLus-Cert-4007497 ANSI/AAMI ES60601-1:2005 with AMD C1: 2009, AMD C2: 2010 and CAN/CSA-C22.2 No. 60601-1 2008 with COR 2:2011+ANSI/AAMI HA60601-1-11 Ed:1



Delivering leading edge, innovative power solutions for more than 30 years....

Model:GTM41080-18VV-F (PCB Mounted)

October 7, 2022

	CHINA SJ/T 11364-2014, China RoHS Chart: <a href="http://en.globtek.com/globtek-rohs.php">http://en.globtek.com/globtek-rohs.php</a>
	Class I Earth Ground
T1.6A 250VAC 	Fuse 60335 T1.6A 250VAC Up to 36 volts
	Indoor Use Only - Mark is on the label or Molded in the case
EFFICIENCY LEVEL 	Efficiency: complies to section 301 of Energy Independence and Security Act (EISA) complies with Energy Star tier 2 (North America), ECP tier 2 (China), MEPS tier 2 (Australia), Code of Conduct (Europe)
 IEC/EN60335-1	NEMKO IEC/EN 60335-1 (Safety of Household and Similar Electrical Appliances, Part 1: General Requirements) up to 36 Volts
 Fuente de alimentación	NOM (Mexico) to NOM-001-SCFI-1993 GTM41080-1507-2.0 5V only
RoHS	Specifications of directive 2011/65/EU Annex VI (ROHS-2) with amendment 2015/863-EU (ROHS-3) <a href="http://www.ce-mark.com/Rohs%20final.pdf">http://www.ce-mark.com/Rohs%20final.pdf</a>
	Semko S-Mark-Cert-EN60601-1 3.1rd Edition ( <a href="http://www.intertek.com/marks/s/">http://www.intertek.com/marks/s/</a> )
	UKCA Certification
	WEEE: Complies with EU 2012/19/EU ( <a href="http://ec.europa.eu/environment/waste/weee/index_en.htm">http://ec.europa.eu/environment/waste/weee/index_en.htm</a> ) Mark is on the label or Molded in the case