

Delivering leading edge, innovative power solutions for more than 30 years....

Model:GT-86240-WWVV-X.X-W2A

October 7, 2022

## GT-86240-WWVV-X.X-W2A

### Information

Model Number	GT-86240-WWVV-X.X-W2A
Description	GT-86240-WWVV-X.X-W2A, ICT/ITE Power Supply, Wall Plug-in, Regulated Switchmode AC-DC Power Supply AC Adaptor, , Input Rating: 100-240V~, 50-60Hz, NEMA 1-15P, North America Blades, Class II 2 Conductors, Output Rating: 24 Watts, Power rating with convection cooling (W) , 12VV in 0.1V increments, Approvals: EAC; CE; China RoHS; Double Insulation; Level VI; LPS 60950; RoHS; Ukraine; WEEE;

### Model Picture



Agency Documents	<a href="http://www.globtek.info/certs/GT-86240(-W2)/">http://www.globtek.info/certs/GT-86240(-W2)/</a>
CE EC-Declaration	<a href="https://www.globtek.com/pdf/ec_declaration/a00a000000FjGajEAF">https://www.globtek.com/pdf/ec_declaration/a00a000000FjGajEAF</a>
RoHS/RoHS2 Declaration	<a href="https://www.globtek.com/pdf/rohs_cert/a00a000000FjGajEAF">https://www.globtek.com/pdf/rohs_cert/a00a000000FjGajEAF</a>
REACH Declaration	<a href="https://www.globtek.com/pdf/iso_certificates/REACH.pdf">https://www.globtek.com/pdf/iso_certificates/REACH.pdf</a>
Conflict Minerals Declaration	<a href="https://www.globtek.com/pdf/conflict-minerals.pdf">https://www.globtek.com/pdf/conflict-minerals.pdf</a>

Delivering leading edge, innovative power solutions for more than **30** years....

Model:GT-86240-WWVV-X.X-W2A

October 7, 2022

**MODEL PARAMETERS**

Type	Wall Plug-in
Technology	Regulated Switchmode AC-DC Power Supply AC Adaptor
Category	ICT/ITE Power Supply
Input Voltage	100-240V~, 50-60Hz
I/P Amps (A)	1A
Wattage (W)	24.0
Vout Range (V)	12V
Efficiency Level	USA DOE Level VI / Eco-design Directive 2009/125/EC, (EU) 2019/1782
Ingress Protection	IPX0
Size (mm)	73.5*42.3*49.5

Delivering leading edge, innovative power solutions for more than 30 years....

Model:GT-86240-WWVV-X.X-W2A

October 7, 2022

# ENCLOSURE

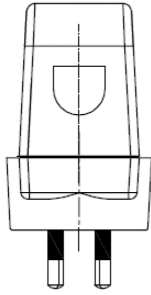

Date Code:WWYY  
WW:Week  
YY:Year

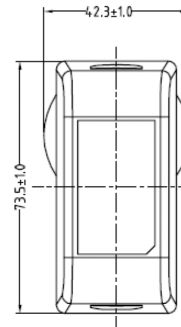
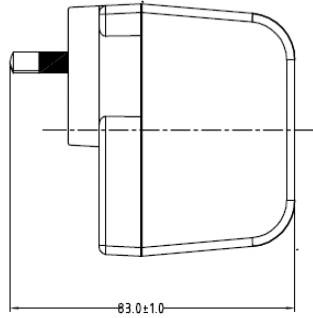
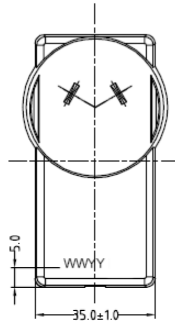

Delivering leading edge, innovative power solutions for more than **30** years....

Model:GT-86240-WWVV-X.X-W2A

October 7, 2022

## RATING TABLE

Model Number	Voltage	Amps(A)	Watts(W)	RFQ
GT-86240-2412-W2A	12 V	2	24.00	<a href="#">RFQ</a>

## SPECIFICATIONS

### A) ELECTRICAL SPECIFICATIONS:

01. Input Voltage: Specified 90-264 Vac, Nameplate rated: 100-240Vac
02. Input Frequency: Specified 47-63 Hz, Nameplate rated 50-60Hz
03. Output Regulation: +/- 5%
04. Ripple and Noise (Vp-p): 300 mVp-p maximum, At 20 MHz, and output parallel with 0.1uF & 47uF capacitors to ground.  
Temperature  
at 25 °C, and nominal input voltage
05. Efficiency: Compliant with Efficiency Level VI and CoC Tier 2 standards
07. No Load Standby Power: <0.075W @ 230Vac
08. Turn-ON Delay: 3 Seconds maximum at nominal input voltage
09. Rise Time: 100mS maximum at nominal input voltage

### B) PROTECTION

01. Over-Voltage: 20VDC maximum
02. Over current protection: 4A maximum with auto-recovery function
03. Short Circuit: Short circuit protection is to be included in the construction of the adaptor. The adaptor is designed to withstand continuous current of a short circuit on the output. The adaptor will be short circuit tolerant for an indefinite period.

### C) SAFETY

01. Dielectric Withstand Voltage: 4242Vdc from primary to secondary
02. Leakage current: 0.25mA maximum, at nominal AC input voltage and frequency
03. ESD: 8KV(air) / 4KV (contact)

### D) OTHER:

01. MTBF: 200,000 Hours @ 25°C ambient temperature
02. Operating Temperature: 0°C to 40°C ambient temperature
03. Humidity: 0% to 90% relative humidity
04. Storage Temperature: -10°C to 80°C
05. Cooling: natural convection cooling
06. ROHS 2: Complies with EU 2011/65/EU and China SJ/T 11363-2006

### E) ENCLOSURE

01. Housing: High impact plastic, 94V0 polycarbonate, non-vented
02. Markings: Label and/or Pad Printed and/or Molded in the case

Delivering leading edge, innovative power solutions for more than 30 years....

Model:GT-86240-WWVV-X.X-W2A

October 7, 2022

## DERATING CURVE

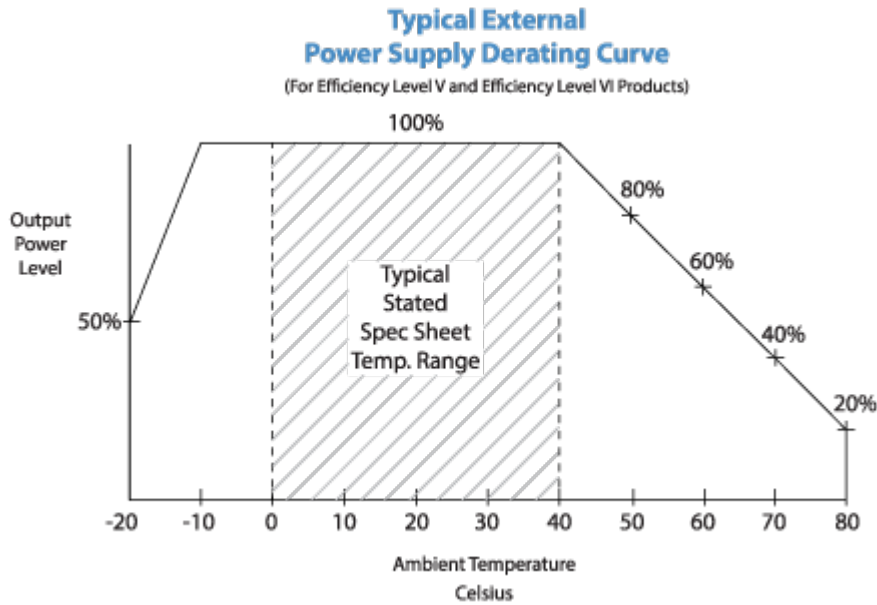

Delivering leading edge, innovative power solutions for more than **30** years....

Model:GT-86240-WWVV-X.X-W2A

October 7, 2022

**INPUT CONFIGURATION**

Description	NEMA 1-15P, North America Blades, Class II 2 Conductors
-------------	---

All NEMA 1 devices are two-wire non-grounding devices (hot-neutral) rated for 125 V maximum. NEMA 1-15P plugs have two parallel flat blades, 0.25 inches (6.35 mm) wide, 0.06 inches (1.524 mm) thick, 0.625-0.718 inches (15.875–18.256 mm) long, and spaced 0.5 inches (12.7 mm) apart.

Delivering leading edge, innovative power solutions for more than 30 years....

Model:GT-86240-WWVV-X.X-W2A

October 7, 2022

**OUTPUT CONFIGURATION**

Common output connector options:

 L Type (Coaxial  
5.5x2.5mm plug)

 C Type (Coaxial  
5.5x2.1mm plug)

 K Type (Coaxial  
3.5x1.3mm plug)

 LL Type (5.5x2.5mm  
Locking 760k type)

 CL Type (5.5x2.1mm  
Locking S761k type)

 ML2 Type (Molex  
housing 43025-0200)

 YL3 Type  
(KPPX-3P)

YL4 Type (KPPX-4P)

 EJ1/2/3/4/5 (EIAJ  
RC-5320A type  
connectors)

 MSB Type (Micro  
USB)

 USBC Type (USB  
Type C)

 Inquire for custom  
design

 For a comprehensive list of options, [click here](#)

Contact GlobTek for your specific requirements or custom solutions.









Delivering leading edge, innovative power solutions for more than 30 years....

Model:GT-86240-WWVV-X.X-W2A

October 7, 2022

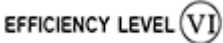
## Approvals

Logo	Description
	CE Mark: tested to comply with EN55022:2010 Class B, EN61000-3-2, EN61000-3-3 including EN61000-4-2, EN61000-4-3, EN61000-4-4, EN61000-4-5, EN61000-4-6N EN61000-4-11; EMI: Complies with EN55011 CLASS B and FCC Part 15B - On label or Molded in case
	CHINA SJ/T 11364-2014, China RoHS Chart: <a href="http://en.globtek.com/globtek-rohs.php">http://en.globtek.com/globtek-rohs.php</a>
	
	Declaration ДС № EAЭC N RU Д-US.KA01.B.10453_19 Custom Union of Russia, Belarus and Kazakhstan <a href="http://www.globtek.com/redirect/?loc=gost-certificate-eac-declaration">http://www.globtek.com/redirect/?loc=gost-certificate-eac-declaration</a>
	Indoor Use Only - Mark is on the label or Molded in the case
	Efficiency: complies to section 301 of Energy Independence and Security Act (EISA) complies with Energy Star tier 2 (North America), ECP tier 2 (China), MEPS tier 2 (Australia), Code of Conduct (Europe)
LPS	Limited Power Source 60950
RoHS	Specifications of directive 2011/65/EU Annex VI (ROHS-2) with amendment 2015/863-EU (ROHS-3) <a href="http://www.ce-mark.com/Rohs%20final.pdf">http://www.ce-mark.com/Rohs%20final.pdf</a>
 10276	Ukraine UKRSepr (Document: <a href="http://www.globtek.com/html/iso_certificates/GT_Ukraine.pdf">www.globtek.com/html/iso_certificates/GT_Ukraine.pdf</a> )
	WEEE: Complies with EU 2012/19/EU ( <a href="http://ec.europa.eu/environment/waste/weee/index_en.htm">http://ec.europa.eu/environment/waste/weee/index_en.htm</a> ) Mark is on the label or Molded in the case