

Delivering leading edge, innovative power solutions for more than 30 years....

Model:GT-86181-WWV.V-W2A

July 25, 2021

GT-86181-WWV.V-W2A

Information

Model Number	GT-86181-WWV.V-W2A
Description	GT-86181-WWV.V-W2A, ICT/ITE Power Supply, Wall Plug-in, Regulated Switchmode AC-DC Power Supply AC Adaptor, , Input Rating: 100-240V~, 50-60 Hz, Australian AS 3112 configuration: SAA 2 pins Class II, Output Rating: 18 Watts, Power rating with convection cooling (W) , 9-12, 15-18V in 0.1V increments, Approvals: EAC; LPS 62368; CB 62368; LPS 62368;

Model Picture



Agency Documents	http://www.globtek.info/certs/GT-86181-W2/
CE EC-Declaration	https://www.globtek.com/pdf/ec_declaration/a0Oa000000FliNrEAJ
RoHS/RoHS2 Declaration	https://www.globtek.com/pdf/rohs_cert/a0Oa000000FliNrEAJ
REACH Declaration	https://www.globtek.com/pdf/iso_certificates/REACH.pdf
Conflict Minerals Declaration	https://www.globtek.com/pdf/conflict-minerals.pdf

Delivering leading edge, innovative power solutions for more than **30** years....

Model:GT-86181-WWV.V-W2A

July 25, 2021

MODEL PARAMETERS

Type	Wall Plug-in
Technology	Regulated Switchmode AC-DC Power Supply AC Adaptor
Category	ICT/ITE Power Supply
Input Voltage	100-240V~, 50-60 Hz
I/P Amps (A)	0.6 A
Wattage (W)	18.0
Vout Range (V)	9-12, 15-18
Efficiency Level	USA DOE Level VI / Eco-design Directive 2009/125/EC, (EU) 2019/1782
Ingress Protection	Indoor Use
Size (mm)	73.5 (L) * 42.3 (W) * 54.75(H) max

Delivering leading edge, innovative power solutions for more than 30 years....

Model:GT-86181-WWV.V-W2A

July 25, 2021

ENCLOSURE

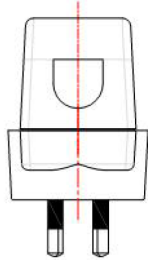

Date Code:WWYY
WW:Week
YY:Year

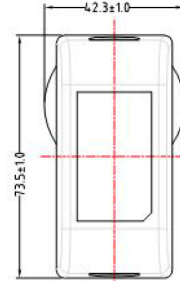
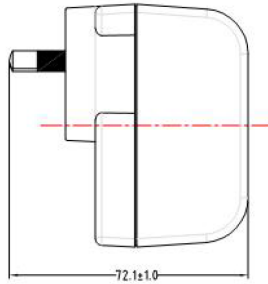
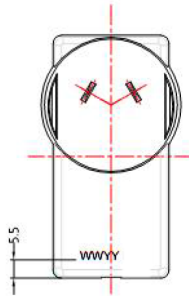

Delivering leading edge, innovative power solutions for more than **30** years....

Model:GT-86181-WWV.V-W2A

July 25, 2021

RATING TABLE

Model Number	Voltage	Amps(A)	Watts(W)	RFQ
GT-86181-1809 -W2A	9 V	2	18.00	RFQ
GT-86181-1810 -W2A	10 V	1.8	18.00	RFQ
GT-86181-1811 -W2A	11 V	1.636	18.00	RFQ
GT-86181-1812 -W2A	12 V	1.5	18.00	RFQ
GT-86181-1815 -W2A	15 V	1.2	18.00	RFQ
GT-86181-1816 -W2A	16 V	1.125	18.00	RFQ
GT-86181-1817 -W2A	17 V	1.058	17.99	RFQ
GT-86181-1818 -W2A	18 V	1	18.00	RFQ

Delivering leading edge, innovative power solutions for more than 30 years....

Model:GT-86181-WWV.V-W2A

July 25, 2021

SPECIFICATIONS

A) ELECTRICAL SPECIFICATIONS:

01. Input Voltage: Specified 90-264 Vac, Nameplate rated: 100-240Vac
02. Input Frequency: Specified 47-63 Hz, Nameplate rated 50-60Hz
03. Inrush Current: at full load, 25° C, cold start
04. Efficiency: Compliant with Efficiency Level VI and CoC Tier 2 standards
05. No Load Standby Power: <0.075W @ 230Vac
06. Line regulation: $\pm 2\%$ At nominal input voltage and full load
07. Total output regulation: $\pm 5\%$
08. Output Voltage: Tolerance $\pm 5\%$
09. Turn On Delay: 3 Seconds maximum at nominal input Voltage
10. Hold Up Time: 5ms min at nominal Input Voltage
11. Ripple Voltage: 300 mVp-p At 20 MHz, and output parallel with Low Impedance 0.1uF & 47uF capacitors. Temperature at 25°C, and nominal input voltage

B) PROTECTION

01. Over voltage protection: Output shut down and auto restart
02. Short circuit protection: The adapter shall not be damaged by short the DC output to Ground
03. Over Load Protection: Output shut down and auto restart

C) SAFETY

01. HI-POT : Input to output : 3000VAC or 4242VDC 10mA 1 minute
02. Leakage current: 0.25mA maximum, at nominal AC input voltage and frequency
03. ESD: 8KV(air) / 4KV (contact)

D) OTHER:

01. MTBF: 200,000 Hours @ 25°C ambient temperature
02. Operating Temperature: 0°C to 40°C ambient temperature
03. Humidity Operating : 20% to 85%
04. Storage Temperature: -20°C to 60°C
05. RoHS 2: Complies with EU 2011/65/EU and China GB/T26572-2011

E) ENCLOSURE

01. Housing: High impact plastic, 94V0 polycarbonate, non-vented
02. Size: 74.5 (L) * 36 (W) * 46(H) mm maximum
03. Weight : 107.0 g $\pm 15\%$
04. Markings: Label and/or Pad Printed and/or Molded in the case

Delivering leading edge, innovative power solutions for more than 30 years....

Model:GT-86181-WWV.V-W2A

July 25, 2021

DERATING CURVE

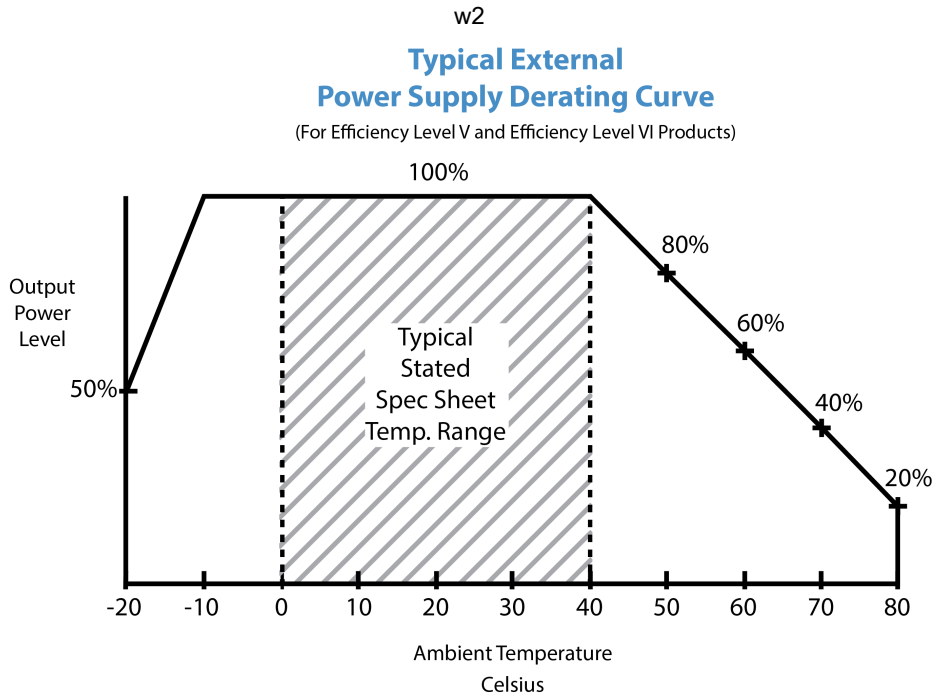

Delivering leading edge, innovative power solutions for more than 30 years....

Model:GT-86181-WWV.V-W2A

July 25, 2021

INPUT CONFIGURATION

Description Australian AS 3112 configuration: SAA 2 pins Class II

Used in [Australia](#), [New Zealand](#), [Fiji](#), [Papua New Guinea](#) and [Tokelau](#), has two flat pins forming an inverted V-shape. These flat blades measure 6.3 by 1.5 mm with the Active and Neutral pins of 17 mm in length set 30° to the vertical on a nominal pitch of 13.7 mm. A standard power outlet in Australia provides a nominal voltage of 230 volts at a maximum of 10 amps and always includes an earth connection. As in the UK, its outlets are individually switched for extra safety. [Argentina](#) uses a similar plug, with pins 1 mm longer.

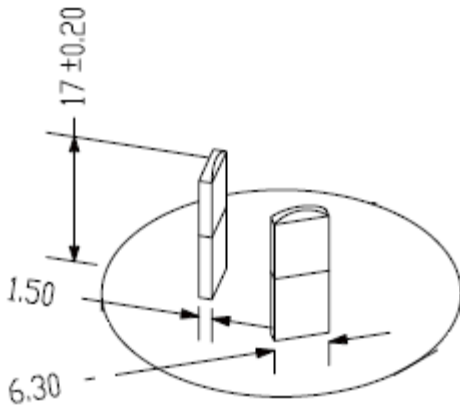

Delivering leading edge, innovative power solutions for more than 30 years....

Model:GT-86181-WWV.V-W2A

July 25, 2021

OUTPUT CONFIGURATION

Common output connector options:

 L Type (Coaxial
5.5x2.5mm plug)

 C Type (Coaxial
5.5x2.1mm plug)

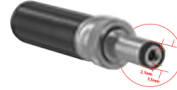
 K Type (Coaxial
3.5x1.3mm plug)

 LL Type (5.5x2.5mm
Locking 760k type)

 CL Type (5.5x2.1mm
Locking S761k type)

 ML2 Type (Molex
housing 43025-0200)

 YL3 Type
(KPPX-3P)

YL4 Type (KPPX-4P)

 EJ1/2/3/4/5 (EIAJ
RC-5320A type
connectors)

 MSB Type (Micro
USB)

 USBC Type (USB
Type C)

 Inquire for custom
design

 For a comprehensive list of options, [click here](#)

Contact GlobTek for your specific requirements or custom solutions.

Delivering leading edge, innovative power solutions for more than **30** years....

Model:GT-86181-WWV.V-W2A

July 25, 2021

Approvals

Logo	Description
No Logo Applicable	CB for IEC 62368-1:2014 (Second Edition)
Conforms to UL STD. 62368-1 Certified to CSA STD C22.2 NO.62368-1	Conforms to UL STD. 62368-1 Certified to CSA STD C22.2 NO.62368-1
	Declaration ДС № EAЭC N RU Д-US.KA01.B.10453_19 Custom Union of Russia, Belarus and Kazakhstan http://www.globtek.com/redirect/?loc=gost-certificate-eac-declaration
LPS	Limited Power Source 62368
LPS	Limited Power Source 62368