

Delivering leading edge, innovative power solutions for more than 30 years....

Model:GTM41133-90VV-x.x-F

September 28, 2021

GTM41133-90VV-x.x-F

Information

Model Number

GTM41133-90VV-x.x-F

Description

GTM41133-90VV-x.x-F, Medical Power Supply, 60601-1-4th Ed. , Open Frame/Internal, Regulated Switchmode AC-DC Power Supply AC Adaptor, , Input Rating: 100-240V~, 50-400Hz, Tyco 640445-5 3 Position Header PIN 1: EARTH, PIN 3: LINE, PIN 5: NEUTRAL, remove Pins 2 and 4, Output Rating: 90 Watts, Power rating with convection cooling (W) , 12-48V in 0.1V increments, Approvals: CB 60950; S-Mark 62368; IRAM; UKCA; Conforms to 62368-1; CB 62368; Book 60601; CE; CE; cETLus ES60601; cETLus 60601-1 3rd; ETL; China RoHS; Class I; GOST-R; Level V; RoHS; Ukraine; WEEE; CB 60601-1 2MOPP; S-Mark 60950; RCM; CE; EAC; Serbia; S-Mark IEC/EN60601-1; CB 60601-1;

Model Picture

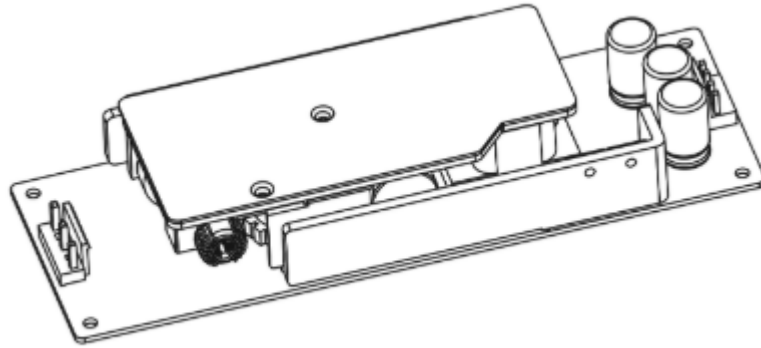

Agency Documents

<http://globtek.info/certs/GTM41133/>

CE EC-Declaration

https://www.globtek.com/pdf/ec_declaration/a0Oa000000JCFgXEAX

RoHS/RoHS2 Declaration

https://www.globtek.com/pdf/rohs_cert/a0Oa000000JCFgXEAX

REACH Declaration

https://www.globtek.com/pdf/iso_certificates/REACH.pdf

Conflict Minerals Declaration

<https://www.globtek.com/pdf/conflict-minerals.pdf>

Delivering leading edge, innovative power solutions for more than **30** years....

Model:GTM41133-90VV-x.x-F

September 28, 2021

MODEL PARAMETERS

Type	Open Frame/Internal
Technology	Regulated Switchmode AC-DC Power Supply AC Adaptor
Category	Medical Power Supply
Input Voltage	100-240V~, 50-400Hz
I/P Amps (A)	1.5A
Wattage (W)	90.0
Vout Range (V)	12-48
Efficiency Level	V
Ingress Protection	
Size (mm)	184*62*25

PROPRIETARY INFORMATION

PROPRIETARY OF GLOBTEK, INC. ANY REPRODUCTION, DISCLOSURE OR USE OF THIS DRAWING, IN WHOLE OR IN PART, IS HEREBY PROHIBITED EXCEPT AS SPECIFIED IN WRITING BY GLOBTEK, INC.

<https://en.globtek.com/datasheet/id/a0Oa000000JCFgX>

Delivering leading edge, innovative power solutions for more than 30 years....

Model:GTM41133-90VV-x.x-F

September 28, 2021

ENCLOSURE

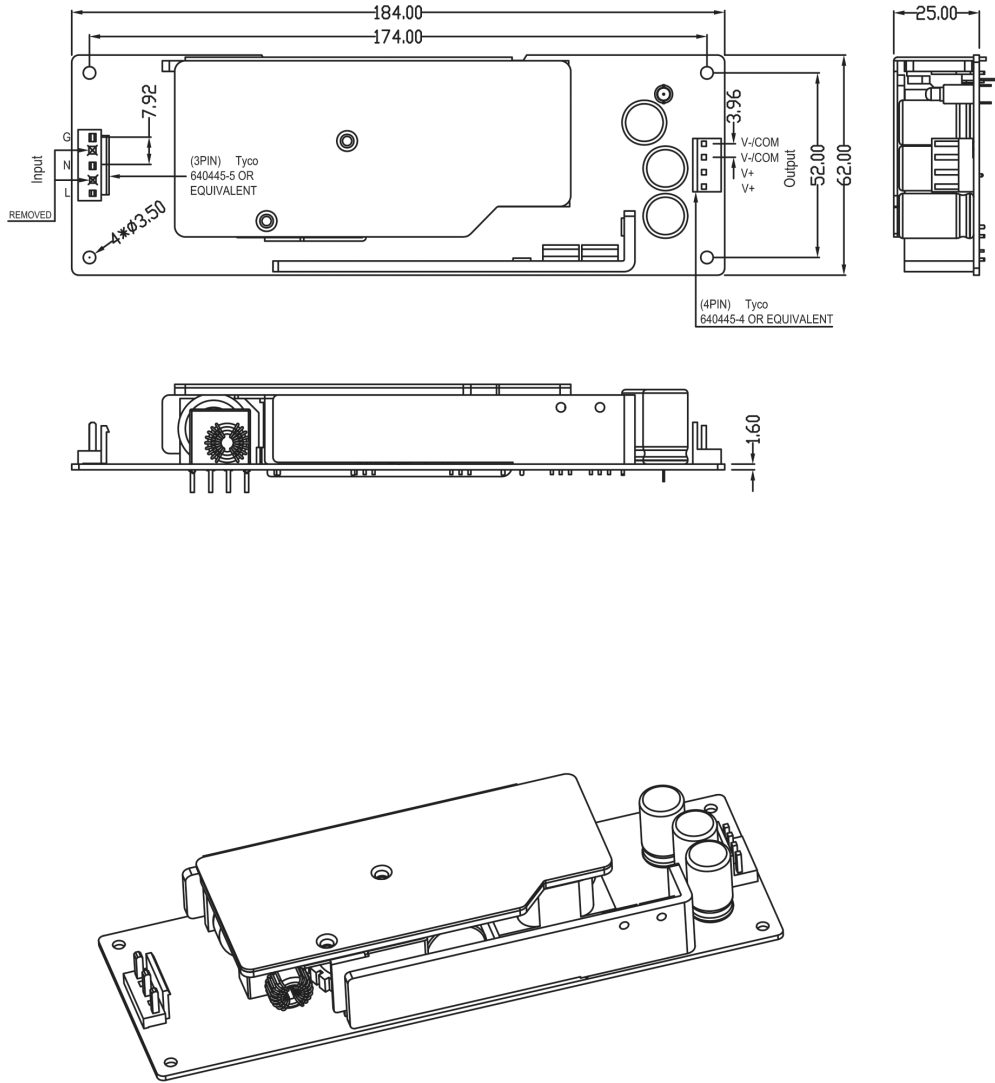

Delivering leading edge, innovative power solutions for more than **30** years....

Model:GTM41133-90VV-x.x-F

September 28, 2021

RATING TABLE

Model Number	Voltage	Amps(A)	Watts(W)	RFQ
GTM41133-9016-4.0-F	12 V	7.5	90.00	RFQ
GTM41133-9016-1.0-F	15 V	1.06	15.90	RFQ
GTM41133-9024-6.0-F	18 V	5	90.00	RFQ
GTM41133-9024-5.0-F	19 V	4.73	89.87	RFQ
GTM41133-9024-F	24 V	3.75	90.00	RFQ
GTM41133-9048-12.0-F	36 V	2.5	90.00	RFQ
GTM41133-9048-10.5-F	37.5 V	2.4	90.00	RFQ
GTM41133-9048-F	48 V	1.875	90.00	RFQ

PROPRIETARY INFORMATION

PROPRIETARY OF GLOBTEK, INC. ANY REPRODUCTION, DISCLOSURE OR USE OF THIS DRAWING, IN WHOLE OR IN PART, IS HEREBY PROHIBITED EXCEPT AS SPECIFIED IN WRITING BY GLOBTEK, INC.

SPECIFICATIONS

A) ELECTRICAL SPECIFICATIONS:

01. Input Voltage: Specified 90-264 Vac, Nameplate rated: 100-240Vac
02. Input Frequency: Specified 47-63 Hz, Nameplate rated 50-60Hz
03. Output Regulation: +/- 5% measured at the output connector
04. Line Voltage Regulation: +/- 1% typical measured at full load
05. Output Ripple (Vp-p): +/-1% or 150 mV whichever is greater, measured at 20 MHz bandwidth with 0.1 uf ceramic capacitor in parallel with 10 uf electrolytic capacitor connected at the end of the output connector at nominal line
06. Turn-ON/OFF Overshoot: 5% maximum, 1 mS typical recovery time for 25% to 50% step load
07. Turn-ON Delay: 1 sec, maximum @ full load, nominal line
08. Hold-Up Time: 8 mS typical @ nominal input voltage and full load
09. Inrush Current: 30/60A maximum cold start @ 115/230Vac input
10. Switching Frequency: 65 KHz typical

B) PROTECTION

01. Over-Voltage: Electronically Protected Zener clamp across the output
02. Short Circuit: Electronically Protected unit will auto recover upon removal of fault
03. Input Protection: Input line fusing

C) SAFETY

01. Dielectric Withstand Voltage: 5656Vdc from primary to secondary
02. Earth Leakage Current: Did not exceed 5 mA in NORMAL CONDITION and 10 mA in SINGLE FAULT CONDITION
03. Earth continuity test:<0.1 Ohm or < 0.2 Ohm when with a non-detachable Power Supply cord, Class I Only
- 04 Touch Current: Did not exceed 100uA NC(Normal condition) 500uA SFC(single fault condition)
05. Primary to Secondary Isolation: 2 MOPP

D) OTHER:

01. MTBF: 200,000 Hours @ 25°C ambient temperature
02. Operating Temperature: 0°C to 40°C ambient temperature
03. Humidity: 0% to 90% relative humidity
04. Storage Temperature: -10°C to 80°C
05. Cooling: Convection
06. Operating Altitude: 5,000 METERS
07. Operating Atmospheric Pressure: 700 hPa TO 1060hPa

E) ENCLOSURE

01. Open Frame
02. Size: 156.0 x 55.2 x 24.1 +/-1.0 mm
03. LED to indicate "Power Out"
04. Markings: Label

Delivering leading edge, innovative power solutions for more than **30** years....

Model:GTM41133-90VV-x.x-F

September 28, 2021

DERATING CURVE

Delivering leading edge, innovative power solutions for more than **30** years....

Model:GTM41133-90VV-x.x-F

September 28, 2021

INPUT CONFIGURATION

Description Tyco 640445-5 3 Position Header PIN 1: EARTH, PIN 3: LINE, PIN 5: NEUTRAL, remove Pins 2 and 4

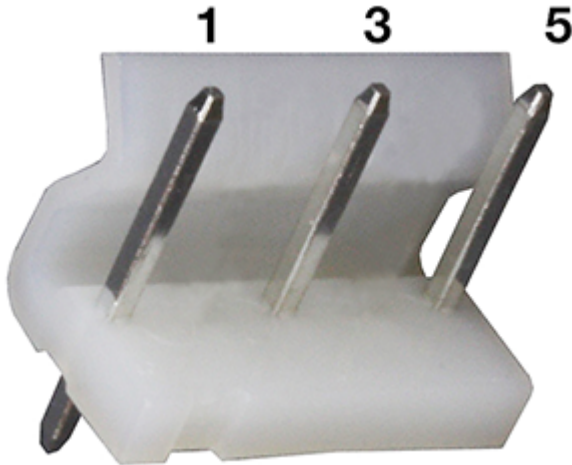

Product Details: <http://www.te.com/catalog/pn/en/640445-5?RQPN=640445-5>



Model:GTM41133-90VV-x.x-F

September 28, 2021







Approvals

Logo	Description
	60601-1 3rd Operating Instructions
No Logo Applicable	CB report IEC 60601-1: 2005 + CORR. 1 (2006) + CORR. 2 (2007) and or EN 60601-1:2006 3rd Edition 2xMOPP
No Logo	IEC 60601-1: 2005 +A1 and IEC 60601-1-11:2015
No Logo Applicable	IEC 60950-1:2005 (Second Edition) + Am 1:2009 + Am 2:2013
No Logo Applicable	CB for IEC 62368-1:2014 (Second Edition)
	CE Certification CE Mark: tested to comply with EN 55032.2012+AC.2013 EN 61000-3-2.2014 EN 61000-3-3.2013 EN 60601-1-2.2015 EN 55024.2010
	CE Mark: tested to comply with EN55022:2006/A1:2007 Class B, EN610003-2, EN610003-3 including EN61000-4-2, EN61000-4-3, EN61000-4-4, EN61000-4-5, EN61000-4-6N EN61000-4-11; EMI: Complies with EN55011 CLASS B and FCC Part 15B - On label or Molded in case
	CE Mark: tested to comply with EN 60601-1-2:2015 Medical electrical equipment Part 1-2: - Mark is on the label or Molded in the case
Conforms to ANSI/AAMI ES 60601-1:2005 Cert. to CAN/CSA Std. C22.2	cETLus ANSI_AAMI ES60601-1_2005
	cETLus-Cert-4007497 ANSI/AAMI ES60601-1:2005 with AMD C1: 2009, AMD C2: 2010 and CAN/CSA-C22.2 No. 60601-1 2008 with COR 2:2011+ANSI/AAMI HA60601-1-11 Ed:1
	CHINA SJ/T 11364-2014, China RoHS Chart: http://en.globtek.com/globtek-rohs.php

Delivering leading edge, innovative power solutions for more than 30 years....

Model:GTM41133-90VV-x.x-F







September 28, 2021

Conforms to UL STD. 62368-1 Certified to CSA STD C22.2 NO.62368-1	Conforms to UL STD. 62368-1 Certified to CSA STD C22.2 NO.62368-1
	Certification # TC RU AR46.B.59626 Custom Union of Russia, Belarus and Kazakhstan
	Information Technology Equipment Safety Part 1: General Requirements >Valid without technical revision: 01Jan2022< [UL 60950-1:2007 Ed.2 +R:14Oct2014]
	GOST-R mark for Russia(Document: http://www.globtek.com/html/iso_certificates/GT_GOST-R.pdf). 03/15/2015. Due to lack of demand, GlobTek will not be renewing it's GOST certification. Please contact your sales engineer for pricing on EAC.
	Indoor Use Only - Mark is on the label or Molded in the case
 DC-E-G71-005.1 PRECAUCION: PARA USO EN EQUIPOS ELECTRONICOS SOLAMENTE	IRAM certificate DC-E-G71-005.1 to IEC 62368-1:2014
EFFICIENCY LEVEL 	Efficiency: complies to section 301 of Energy Independence and Security Act (EISA) complies with Energy Star tier 2 (North America), ECP tier 2 (China), MEPS tier 2 (Australia), Code of Conduct (Europe)
 SAA-170038-EA	RCM certificate SAA-170038-EA; Australia and New Zealand Regulatory Compliance, Mark (http://rcmstandards.org.au/rcmfaq/rcmfaq.htm)
RoHS	Specifications of directive 2011/65/EU Annex VI (ROHS-2) with amendment 2015/863-EU (ROHS-3) http://www.ce-mark.com/Rohs%20final.pdf

Delivering leading edge, innovative power solutions for more than **30** years....

Model:GTM41133-90VV-x.x-F

September 28, 2021

 Intertek	S-Mark Certificate EN 60950-1:2006 + A11:2009 + A1:2010 + A12:2011+A2:2013 (http://www.intertek.com/marks/s/)
 Intertek	S-Mark Certificate EN 62368-1:2014 + A11 (http://www.intertek.com/marks/s/)
 Intertek IEC/EN60601-1	Semko S-Mark-Cert-EN60601-1 3.1rd Edition (http://www.intertek.com/marks/s/)
 H 005 19	Serbia Approval - Conformity mark must be at least 5 mm high.
	UKCA Certification
 10276	Ukraine UKRSepra (Document: www.globtek.com/html/iso_certificates/GT_Ukraine.pdf)
	WEEE: Complies with EU 2012/19/EU (http://ec.europa.eu/environment/waste/weee/index_en.htm) Mark is on the label or Molded in the case