

Delivering leading edge, innovative power solutions for more than 30 years....

Model:GTM96700-CWWVV-F

November 27, 2020

GTM96700-CWWVV-F

Information

Model Number

GTM96700-CWWVV-F

Description

GTM96700-CWWVV-F, Medical Power Supply, Open Frame/Internal, Regulated Switchmode AC-DC Power Supply AC Adaptor, , Input Rating: 100-240V~, 50-60 Hz, Molex 09-65-2058 5 Position Header Pin 1: Earth, Pin 2: Removed, PIN 3: Neutral, Pin 4: removed, Pin 5: Line, Output Rating: 70 Watts, Power rating with convection cooling (W) , 5-56V in 0.1V increments, Approvals: EAC; CB 60950; CB 62368; ETL; ETL; S-Mark IEC/EN 60601-1 60950; Morocco; CB 60601-1; CE; China RoHS; Class I; CB 60601-1 2MOPP; RoHS; Ukraine; VCCI; WEEE;

Model Picture



Agency Documents

<http://www.globtek.info/certs/GTM96700/>

CE EC-Declaration

https://www.globtek.com/pdf/ec_declaration/a0Oa000000MEU7XEAX

RoHS/RoHS2 Declaration

https://www.globtek.com/pdf/rohs_cert/a0Oa000000MEU7XEAX

REACH Declaration

https://www.globtek.com/pdf/iso_certificates/REACH.pdf

Conflict Minerals Declaration

<https://www.globtek.com/pdf/conflict-minerals.pdf>

Delivering leading edge, innovative power solutions for more than **30** years....

Model:GTM96700-CWWVV-F

November 27, 2020

MODEL PARAMETERS

Type	Open Frame/Internal
Technology	Regulated Switchmode AC-DC Power Supply AC Adaptor
Category	Medical Power Supply
Input Voltage	100-240V~, 50-60 Hz
I/P Amps (A)	2.0A
Wattage (W)	70.0
Vout Range (V)	5-56
Efficiency Level	N/A
Ingress Protection	
Size (mm)	127x76.2x25

PROPRIETARY INFORMATION

PROPRIETARY OF GLOBTEK, INC. ANY REPRODUCTION, DISCLOSURE OR USE OF THIS DRAWING, IN WHOLE OR IN PART, IS HEREBY PROHIBITED EXCEPT AS SPECIFIED IN WRITING BY GLOBTEK, INC.

<http://en.globtek.com/datasheet/id/a0Oa000000MEU7X>

Delivering leading edge, innovative power solutions for more than 30 years....

Model:GTM96700-CWWVV-F

November 27, 2020

ENCLOSURE

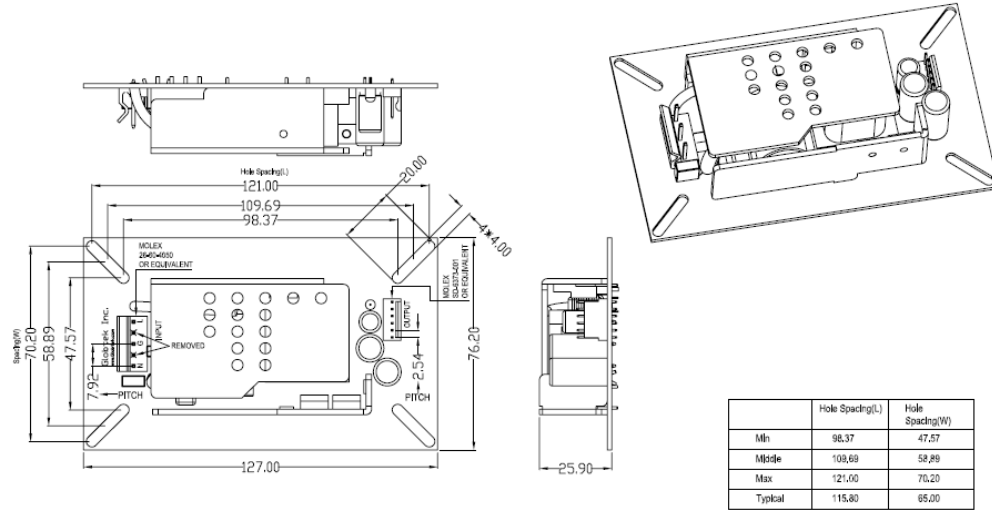

Delivering leading edge, innovative power solutions for more than **30** years....

Model:GTM96700-CWWVV-F

November 27, 2020

RATING TABLE

Model Number	Voltage	Amps(A)	Watts(W)	RFQ
GTM96700-C4005-F	5 V	8	40.00	RFQ
GTM96700-C4806-F	6 V	8	48.00	RFQ
GTM96700-C4907-F	7 V	7	49.00	RFQ
GTM96700-C4907.5-F	7.5 V	6.53	48.98	RFQ
GTM96700-C4909-F	9 V	5.44	48.96	RFQ
GTM96700-C5410-F	10 V	5.42	54.20	RFQ
GTM96700-C6512-F	12 V	5.41	64.92	RFQ
GTM96700-C6515-F	15 V	4.33	64.95	RFQ
GTM96700-C6518-6	18 V	3.61	64.98	RFQ
GTM96700-C6519-F	19 V	3.42	64.98	RFQ
GTM96700-C6520-F	20 V	3.25	65.00	RFQ
GTM96700-C6524-F	24 V	2.708	64.99	RFQ
GTM96700-C6530-F	30 V	2.167	65.01	RFQ
GTM96700-C6836-F	36 V	1.889	68.00	RFQ
GTM96700-C7048-F	48 V	1.458	69.98	RFQ
GTM96700-C7056-F	56 V	1.25	70.00	RFQ

SPECIFICATIONS

A) ELECTRICAL SPECIFICATIONS:

01. Input Voltage: Specified 90-264 Vac, Nameplate rated: 100-240Vac, with optional 90-305Vac, Nameplate rated: 100-277Vac
02. Input Frequency: Specified 47-63 Hz, Nameplate rated 50-60Hz
03. Output Regulation: +/- 3% measured at the output connector
04. Line Voltage Regulation: +/- 0.5% maximum measured at full load
05. Output Ripple (Vp-p): +/- 1% of output voltage, Vp-p, max
06. Turn-ON/OFF: 5% maximum, 1 mS typical recovery time for 25% step load
07. Turn-ON Delay: 1 Sec max
08. Hold-Up Time: 10 mS typical @ nominal input voltage and full load
09. Inrush Current: 30A maximum @ 115 Vac input, 60A maximum @ 230 Vac input
10. Switching Frequency: 65 KHz typical
11. Efficiency: 87% @ 115Vac, 89% @ 230Vac typical at full load
12. No Load Power: < 300mW @ 230Vac

B) PROTECTION

01. Overvoltage Protection: 110% to 130% of nominal output voltage, and less than 60Vdc
02. Short Circuit/Over-load: momentary short circuit protected, output will auto recover upon removal of short
03. Input Protection: Input line fusing and 300Vac MOV

C) SAFETY

01. Dielectric Withstand Voltage: 4000Vac / 5656Vdc from primary to secondary
02. [Output Isolation Options](#): Class I or Class II
03. Earth Leakage Current: Does not exceed 300uA in NORMAL CONDITION and 1000uA in SINGLE FAULT CONDITION
04. Output Leakage Current: Does not exceed 100uA NC(Normal condition) 300uA SFC(single fault condition)
05. Means of Protection: 2 x MOPP
06. Compliant Standards: See listings at end of this drawing for specifics

D) EMC

EN 60601-1-2, 4th edition

Emissions, per EN 55032, EN 61000-6-3, EN 61000-6-4, CISPR11 and CISPR22

Conducted Emissions: Class B, FCC Part 15, Class B

Radiated Emissions: Class B, FCC Part 15, Class B

Line Frequency Harmonics EN61000-3-2, Class A

Voltage Fluctuations/Flicker EN61000-3-3

Immunity, per EN 55024, EN 61000-6-1, EN 61000-6-2

Static Discharge Immunity EN61000-4-2, 10kV Contact Discharge, 20kV air discharge

Radiated RF Immunity EN61000-4-3, 10V/m 80-1000MHz, 3V/m 1-2.7GHz, 80% 1KHz AM.

EFT/Burst Immunity EN61000-4-4, 4kV/100kHz.

Line Surge Immunity EN61000-4-5, 2kV differential, 4kV common-mode

Conducted RF Immunity EN61000-4-6, 3Vrms, 80% 1KHz AM

Power Frequency Magnetic Field Immunity EN61000-4-8, 3A/m

Voltage Dip Immunity EN61000-4-11, Criteria

PROPRIETARY INFORMATION

PROPRIETARY OF GLOBTEK, INC. ANY REPRODUCTION, DISCLOSURE OR USE OF THIS DRAWING, IN WHOLE OR IN PART, IS HEREBY PROHIBITED EXCEPT AS SPECIFIED IN WRITING BY GLOBTEK, INC.

<http://en.globtek.com/datasheet/id/a0Oa000000MEU7X>

Delivering leading edge, innovative power solutions for more than **30** years....

Model:GTM96700-CWWVV-F

November 27, 2020

E) OTHER

01. MTBF: 1,000,000 Hours @ 50°C ambient temperature, Full Load
02. Operating Temperature: -10°C to 50°C ambient temperature
03. Humidity: 0% to 95% relative humidity
04. Storage Temperature: -30°C to 80°C
05. Cooling: Convection
06. Elevation: 5000M
07. ROHS 2: Complies with EU 2011/65/EU and China SJ/T 11363-2006
08. Green Output Power indication LED

F) MECHANICAL FORMAT

01. Type: Open Frame
02. Size: B suffix version, (2"x4"), 101.6 x 50.8 x 30.5 mm
03. Size: C suffix version, (3"x5"), 127.0 x 76.2 x 30.5 mm

G) SPECIAL OPTIONS

01. Custom Label Markings
 02. Integral Earth Wire for Class I
 03. Short term Output Surge Capability
 04. Reduced Leakage Current versions
 05. Tightened output voltage tolerance
 06. Reduced output ripple level
 07. Low Temperature operation, down to -40°C
 08. Over-Temperature Protection, Latched Shut-Down
 09. Special Input or Output Connectors
-

Delivering leading edge, innovative power solutions for more than 30 years....

Model:GTM96700-CWWVV-F

November 27, 2020

DERATING CURVE

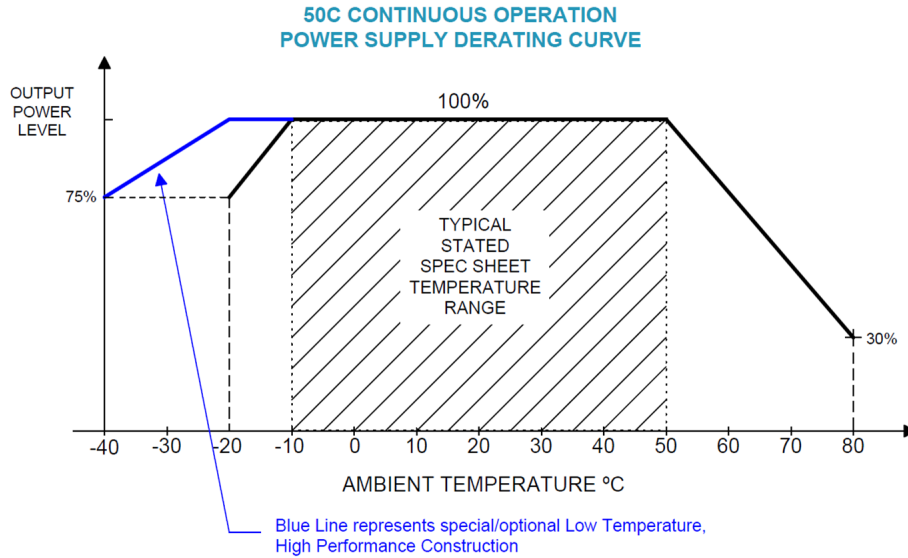

Note: Models $\geq 24V$ may be operated at 70W continuous power, if the ambient temperature is $\leq 40^{\circ}C$.

Delivering leading edge, innovative power solutions for more than **30** years....

Model:GTM96700-CWWVV-F

November 27, 2020

INPUT CONFIGURATION

Description Molex 09-65-2058 5 Position Header Pin 1: Earth, Pin 2: Removed, PIN 3: Neutral, Pin 4: removed, Pin 5: Line

Document: http://www.molex.com/pdm_docs/sd/009652058_sd.pdf

Catalog Page: http://www.molex.com/molex/products/datasheet.jsp?part=active/0009652058_PCB_HEADERS.xml

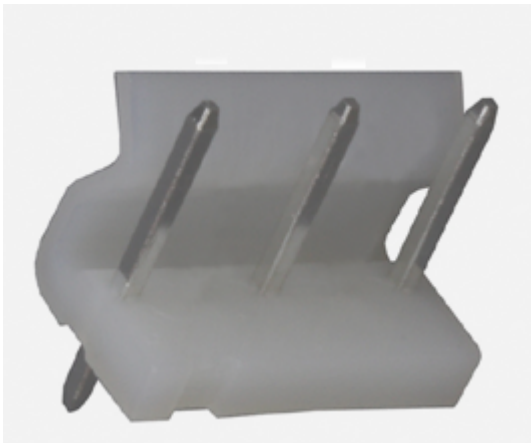
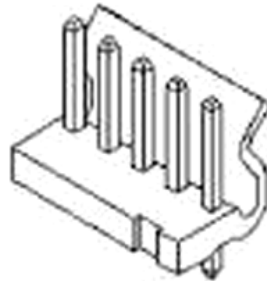
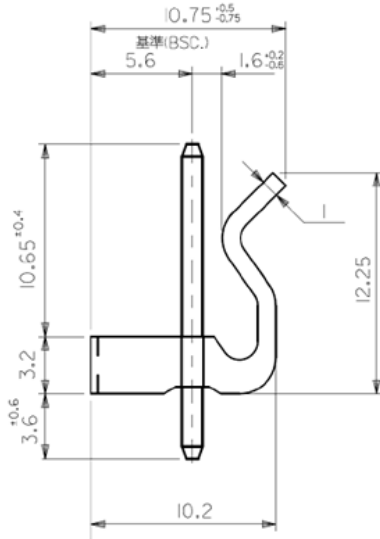

Mates With Part(s):







5195 SPOX™ Crimp Housing, **5239** KK® Crimp Housing

Delivering leading edge, innovative power solutions for more than 30 years....

Model:GTM96700-CWWVV-F

November 27, 2020







Approvals

Logo	Description
	Attention Mark / Refer to operating manual for operating and service instructions
No Logo Applicable	CB report IEC 60601-1: 2005 + CORR. 1 (2006) + CORR. 2 (2007) and or EN 60601-1:2006 3rd Edition
No Logo Applicable	
No Logo	CB Certificate IEC 60950-1:2005 (2nd Edition), Am 1: 2009 + Am 2:2013, CB report IEC 60950-1:2005 (2nd Edition), Am 1: 2009 + Am 2:2013
No Logo Applicable	CB for IEC 62368-1:2014 (Second Edition)
	CE Mark: tested to comply with EN61000-3-2, EN61000-3-3 and EN50082-1, including EN61000-4-2, EN61000-4-3, EN61000-4-4, EN61000-4-5, EN61000-4-6, EN61000-4-8, EN61000-4-11, EN61001-1-2-2007 EMI: Complies with EN55011 CLASS B and FCC Part 15 B
	CHINA SJ/T 11364-2014, China RoHS Chart: http://en.globtek.com/globtek-rohs.php
	Class I Earth Ground
	Declaration ДС № EAЭC N RU Д-US.KA01.B.10453_19 Custom Union of Russia, Belarus and Kazakhstan http://www.globtek.com/redirect/?loc=gost-certificate-eac-declaration
	
	

Delivering leading edge, innovative power solutions for more than 30 years....

Model:GTM96700-CWWVV-F

November 27, 2020

	Indoor Use Only - Mark is on the label or Molded in the case
	Morocco SDoC declaration http://www.globtek.info/certs/Morocco%20SDoC%20Declaration/
RoHS	Specifications of directive 2011/65/EU Annex VI (ROHS-2) with amendment 2015/863-EU (ROHS-3) http://www.ce-mark.com/Rohs%20final.pdf
	Semko S-Mark-Cert-EN60601-1 and EN60950-1
	UKCA Certification
	Ukraine UKRSepra (Document: www.globtek.com/html/iso_certificates/GT_Ukraine.pdf)
	Japan: Voluntary Control Council for Interference (VCCI)
	WEEE: Complies with EU 2012/19/EU (http://ec.europa.eu/environment/waste/weee/index_en.htm) Mark is on the label or Molded in the case