

Delivering leading edge, innovative power solutions for more than 30 years....

Model:GT-83081-12VV-X.X-W2E

October 31, 2020

**GT-83081-12VV-X.X-W2E**

**Information**

Model Number	GT-83081-12VV-X.X-W2E
Description	GT-83081-12VV-X.X-W2E, ITE Power Supply, Wall Plug-in, Regulated Switchmode AC-DC Power Supply AC Adaptor, , Input Rating: 100-240V~, 50-60 Hz, European CEE 7/16 configuration:EN 50075 Europlug 2 PIN, Output Rating: 12 Watts, Power rating with convection cooling (W) , 3.3~28V in 0.1V increments, Approvals: Level V; CE; China RoHS; Double Insulation; GOST-R; RoHS; Ukraine; WEEE; LPS 60950;

**Model Picture**



Agency Documents	<a href="http://www.globtek.info/certs/GT-83081-W2Z/">http://www.globtek.info/certs/GT-83081-W2Z/</a>
CE EC-Declaration	<a href="https://www.globtek.com/pdf/ec_declaration/a0Oa000000MEsSREA1">https://www.globtek.com/pdf/ec_declaration/a0Oa000000MEsSREA1</a>
RoHS/RoHS2 Declaration	<a href="https://www.globtek.com/pdf/rohs_cert/a0Oa000000MEsSREA1">https://www.globtek.com/pdf/rohs_cert/a0Oa000000MEsSREA1</a>
REACH Declaration	<a href="https://www.globtek.com/pdf/iso_certificates/REACH.pdf">https://www.globtek.com/pdf/iso_certificates/REACH.pdf</a>
Conflict Minerals Declaration	<a href="https://www.globtek.com/pdf/conflict-minerals.pdf">https://www.globtek.com/pdf/conflict-minerals.pdf</a>

Delivering leading edge, innovative power solutions for more than **30** years....

Model:GT-83081-12VV-X.X-W2E

October 31, 2020

**MODEL PARAMETERS**

Type	Wall Plug-in
Technology	Regulated Switchmode AC-DC Power Supply AC Adaptor
Category	ITE Power Supply
Input Voltage	100-240V~, 50-60 Hz
I/P Amps (A)	0.5A
Wattage (W)	12.0
Vout Range (V)	3.3~28
Efficiency Level	V
Ingress Protection	IPX0
Size (mm)	77.7*69.0*28.8

Delivering leading edge, innovative power solutions for more than 30 years....

Model:GT-83081-12VV-X.X-W2E

October 31, 2020

# ENCLOSURE

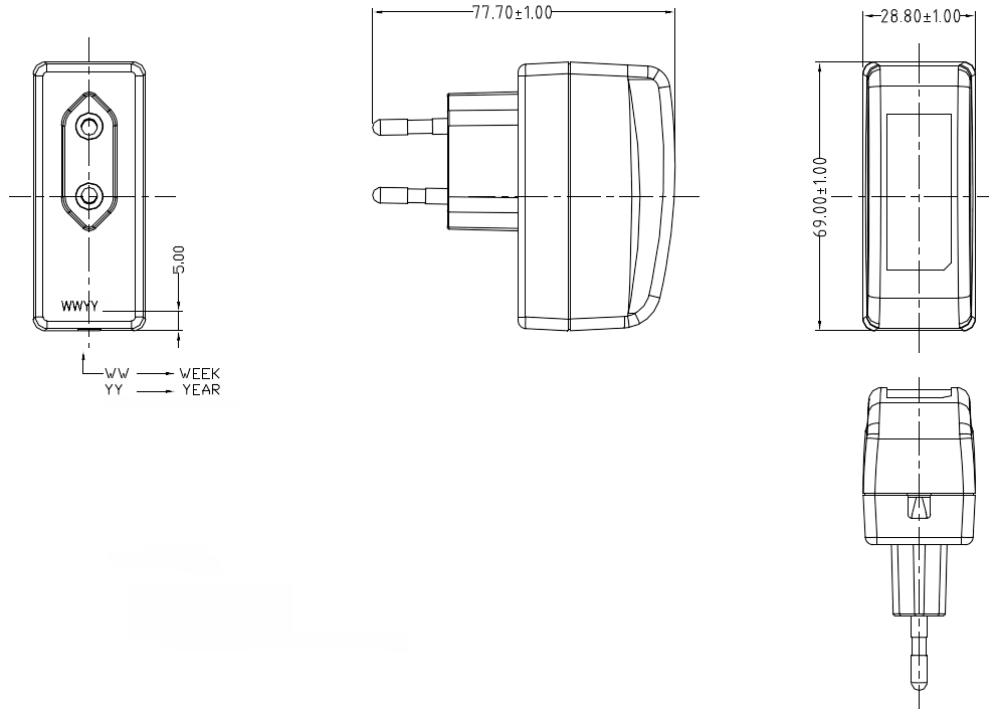

Delivering leading edge, innovative power solutions for more than **30** years....

Model:GT-83081-12VV-X.X-W2E

October 31, 2020

**RATING TABLE**

Model Number	Voltage	Amps(A)	Watts(W)	RFQ
GT-83081-0703.3-W2E	3.3 V	2	6.60	<a href="#">RFQ</a>
GT-83081-1005-W2E	5 V	2	10.00	<a href="#">RFQ</a>
GT-83081-0906-W2E	6 V	1.5	9.00	<a href="#">RFQ</a>
GT-83081-0807.5-W2E	7.5 V	1	7.50	<a href="#">RFQ</a>
GT-83081-0909-W2E	9 V	1	9.00	<a href="#">RFQ</a>
GT-83081-1212-W2E	12 V	1	12.00	<a href="#">RFQ</a>
GT-83081-1213.3-W2E	13.3 V	0.9	11.97	<a href="#">RFQ</a>
GT-83081-1215-W2E	15 V	0.8	12.00	<a href="#">RFQ</a>
GT-83081-1028-W2E	28 V	0.35	9.80	<a href="#">RFQ</a>

## SPECIFICATIONS

### A) ELECTRICAL SPECIFICATIONS:

01. Input Voltage: Specified 90-264 Vac, Nameplate rated: 100-240Vac
02. Input Frequency: Specified 47-63 Hz, Nameplate rated 50-60Hz
03. Output Regulation: +/- 5%
04. Ripple and Noise (Vp-p): 100 mVp-p maximum, At 20 MHz, and output parallel with 0.1uF & 10uF capacitors to ground. Temperature at 25 °C, and nominal input voltage
05. Average Efficiency: 75.95% minimum, At 115VAC/230VAC input voltage meet efficiency level: V
06. Turn-ON Delay: 3 Seconds maximum at nominal input voltage
07. Rise Time: 100mS maximum at nominal input voltage
08. Switching Frequency: 50 KHz typical

### B) PROTECTION

01. Over-Voltage: protected
02. Over current protection: 2.2A maximum with auto-recovery function
03. Short Circuit: Short circuit protection is to be included in the construction of the adaptor. The adaptor is designed to withstand continuous current of a short circuit on the output. The adaptor will be short circuit tolerant for an indefinite period.

### C) SAFETY

01. Dielectric Withstand Voltage: Primary To Secondary: 3000VAC 10mA 1minute or 4242VDC 10mA 1minute
02. Leakage Current: 0.25mA maximum, at nominal AC input voltage and frequency

### D) OTHER:

01. MTBF: 200,000 Hours @ 25°C ambient temperature
02. Operating Temperature: 0°C to 40°C ambient temperature
03. Humidity: 0% to 90% relative humidity
04. Storage Temperature: -10°C to 80°C
05. Cooling: natural convection cooling
06. ROHS 2: Complies with EU 2011/65/EU and China SJ/T 11363-2006

### E) ENCLOSURE

01. Housing: High impact plastic, 94V0 polycarbonate, non-vented
02. Markings: Label and/or Pad Printed and/or Molded in the case

Delivering leading edge, innovative power solutions for more than **30** years....

Model:GT-83081-12VV-X.X-W2E

October 31, 2020

## DERATING CURVE

---

Delivering leading edge, innovative power solutions for more than 30 years....

Model:GT-83081-12VV-X.X-W2E

October 31, 2020

### INPUT CONFIGURATION

Description European CEE 7/16 configuration:EN 50075 Europlug 2 PIN

The prongs of the Europlug are 19 mm long. They consist of a 9 mm long conductive tip of 4 mm diameter with a rounded ending, followed by a 10 mm long flexible insulated shaft of not more than 3.8 mm diameter. The two prongs are not exactly parallel and converge slightly; their centres are 19 mm apart at the tip and 18.6 mm apart at the base. The elasticity of the converging prongs provides sufficient contact force for the Europlug's current rating with a variety of socket-hole arrangements. The entire plug is 35.3 mm wide and 13.7 mm high, and must not exceed these dimensions within 18 mm behind its front plane (this allows for the recesses on many European socket types). The left and right side of the plug are formed by surfaces that are at 45° relative to the horizontal plan.

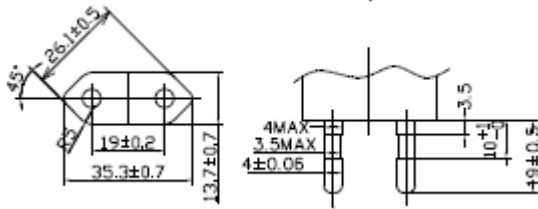

Delivering leading edge, innovative power solutions for more than 30 years....

Model:GT-83081-12VV-X.X-W2E

October 31, 2020

**OUTPUT CONFIGURATION**

Common output connector options:

 L Type (Coaxial  
5.5x2.5mm plug)

 C Type (Coaxial  
5.5x2.1mm plug)

 K Type (Coaxial  
3.5x1.3mm plug)

 LL Type (5.5x2.5mm  
Locking 760k type)

 CL Type (5.5x2.1mm  
Locking S761k type)

 ML2 Type (Molex  
housing 43025-0200)

 YL3 Type  
(KPPX-3P)

YL4 Type (KPPX-4P)

 EJ1/2/3/4/5 (EIAJ  
RC-5320A type  
connectors)

 MSB Type (Micro  
USB)

 USBC Type (USB  
Type C)

 Inquire for custom  
design

 For a comprehensive list of options, [click here](#)

Contact GlobTek for your specific requirements or custom solutions.











Delivering leading edge, innovative power solutions for more than 30 years....

Model:GT-83081-12VV-X.X-W2E

October 31, 2020

## Approvals

Logo	Description
	Attention Mark / Refer to operating manual for operating and service instructions
	CE Mark: tested to comply with EN55022:2006/A1:2007 Class B, EN610003-2, EN610003-3 including EN61000-4-2, EN61000-4-3, EN61000-4-4, EN61000-4-5, EN61000-4-6N EN61000-4-11; EMI: Complies with EN55011 CLASS B and FCC Part 15B - On label or Molded in case
	CHINA SJ/T 11364-2014, China RoHS Chart: <a href="http://en.globtek.com/globtek-rohs.php">http://en.globtek.com/globtek-rohs.php</a>
	GOST-R mark for Russia(Document: <a href="http://www.globtek.com/html/iso_certificates/GT_GOST-R.pdf">http://www.globtek.com/html/iso_certificates/GT_GOST-R.pdf</a> ). 03/15/2015. Due to lack of demand, GlobTek will not be renewing it's GOST certification. Please contact your sales engineer for pricing on EAC.
	Indoor Use Only - Mark is on the label or Molded in the case
<b>EFFICIENCY LEVEL</b> 	Efficiency: complies to section 301 of Energy Independence and Security Act (EISA) complies with Energy Star tier 2 (North America), ECP tier 2 (China), MEPS tier 2 (Australia), Code of Conduct (Europe)
LPS	Limited Power Source 60950
RoHS	Specifications of directive 2011/65/EU Annex VI (ROHS-2) with amendment 2015/863-EU (ROHS-3) <a href="http://www.ce-mark.com/Rohs%20final.pdf">http://www.ce-mark.com/Rohs%20final.pdf</a>
 10276	Ukraine UKRSepr (Document: <a href="http://www.globtek.com/html/iso_certificates/GT_Ukraine.pdf">www.globtek.com/html/iso_certificates/GT_Ukraine.pdf</a> )
	WEEE: Complies with EU 2012/19/EU ( <a href="http://ec.europa.eu/environment/waste/weee/index_en.htm">http://ec.europa.eu/environment/waste/weee/index_en.htm</a> ) Mark is on the label or Molded in the case

Delivering leading edge, innovative power solutions for more than **30** years....

Model:GT-83081-12VV-X.X-W2E

October 31, 2020

