

Delivering leading edge, innovative power solutions for more than 30 years....

Model:GT-46200-20VV-x.x-T2

June 24, 2021

DOE EPS 2.0 Level VI Desktop Power Supply Class II AC Adapter, 20w, output 5-6 VDC

Information

Model Number

GT-46200-20VV-x.x-T2

Description

GT-46200-20VV-x.x-T2, ICT/ITE Power Supply, Desktop/External, Regulated Switchmode AC-DC Power Supply AC Adaptor, , Input Rating: 100-240V~, 50-60 Hz, IEC 60320/C8 AC Inlet connector, Class II, Non-Earth Ground (aka "Figure-8"), Output Rating: 20 Watts, Power rating with convection cooling (W) , 5-6V in 0.1V increments, Approvals: 230V CoC Tier 2; EAC; cULus; UKCA; Morocco; CB 62368; SIQ; CE; China RoHS; IP40; Level VI; LPS 60950; PSE; RoHS; Ukraine; VCCI; WEEE; Double Insulation; CCC; PSE; cULus; RCM; CE;

Model Picture



Agency Documents

<http://www.globtek.info/certs/GT-46200-20VV-X.X-TZ/>

CE EC-Declaration

https://www.globtek.com/pdf/ec_declaration/a0Oa000000MFKlvEAH

RoHS/RoHS2 Declaration

https://www.globtek.com/pdf/rohs_cert/a0Oa000000MFKlvEAH

REACH Declaration

https://www.globtek.com/pdf/iso_certificates/REACH.pdf

Conflict Minerals Declaration

<https://www.globtek.com/pdf/conflict-minerals.pdf>

Delivering leading edge, innovative power solutions for more than **30** years....

Model:GT-46200-20VV-x.x-T2

June 24, 2021

MODEL PARAMETERS

| | |
|--------------------|---|
| Type | Desktop/External |
| Technology | Regulated Switchmode AC-DC Power Supply AC Adaptor |
| Category | ICT/ITE Power Supply |
| Input Voltage | 100-240V~, 50-60 Hz |
| I/P Amps (A) | 0.5 A |
| Wattage (W) | 20.0 |
| Vout Range (V) | 5-6 |
| Efficiency Level | USA DOE Level VI / Eco-design Directive 2009/125/EC, (EU) 2019/1782 |
| Ingress Protection | Indoor Use |
| Size (mm) | 80.6*50.0*31.0 |

PROPRIETARY INFORMATION

PROPRIETARY OF GLOBTEK, INC. ANY REPRODUCTION, DISCLOSURE OR USE OF THIS DRAWING, IN WHOLE OR IN PART, IS HEREBY PROHIBITED EXCEPT AS SPECIFIED IN WRITING BY GLOBTEK, INC.

<https://en.globtek.com/datasheet/id/a0Oa000000MFKlv>

Delivering leading edge, innovative power solutions for more than 30 years....

Model:GT-46200-20VV-x.x-T2

June 24, 2021

ENCLOSURE

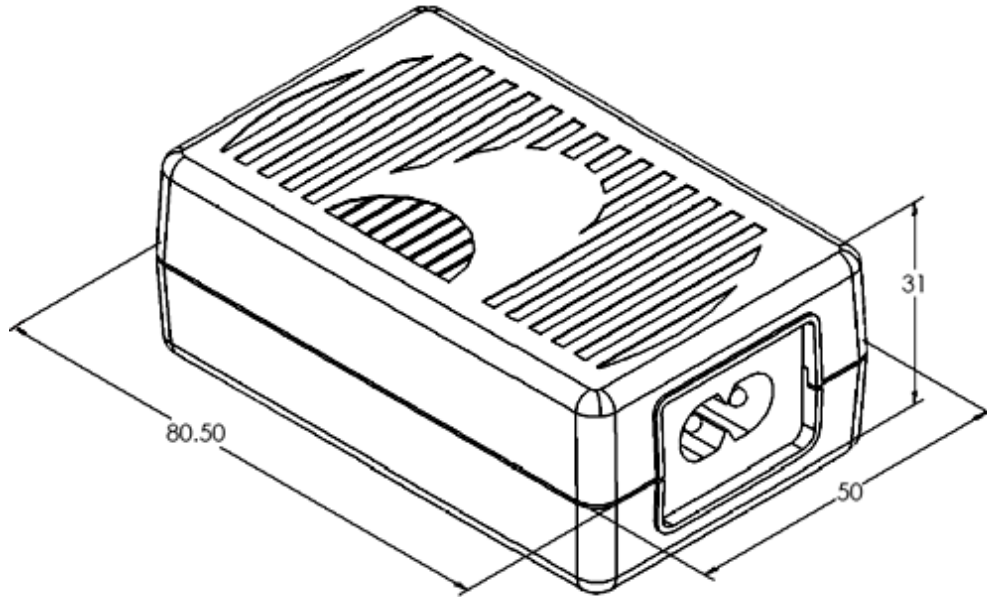

Delivering leading edge, innovative power solutions for more than **30** years....

Model:GT-46200-20VV-x.x-T2

June 24, 2021

RATING TABLE

| Model Number | Voltage | Amps(A) | Watts(W) | RFQ |
|-----------------------|---------|---------|----------|---------------------|
| GT-46200-2005-T2 | 5 V | 4 | 20.00 | RFQ |
| GT-46200-1806-0.05-T2 | 5.95 V | 3 | 17.85 | RFQ |

SPECIFICATIONS

A) ELECTRICAL SPECIFICATIONS:

01. Input Voltage: Specified 90-264 Vac, Nameplate rated: 100-240Vac
 02. Input Frequency: Specified 47-63 Hz, Nameplate rated 50-60Hz
 03. Inrush Current: 50A Max. at 115VAC cold start, 100A Max. at 230VAC cold start
 04. Average Efficiency: 83.08% Min (CEC & DOE LEVEL VI Compliant), 83.68% Min (ErP Tier2 Compliant)
 05. Input power(no load): <0.1W (CEC & DOE LEVEL VI Compliant), <0.075W (ErP Tier2 Compliant)
 07. Output Voltage tolerance: $\pm 5\%$
 08. Load regulation: $\pm 5\%$
 09. Output Voltage: Tolerance $\pm 5\%$
 10. Turn On Delay: 3000 mS MAX at 115 VAC Full Load
 11. Hold Up Time: 10 mS Min at 100 VAC Full Load
 12. Ripple Voltage: 150mV (p-p): Input :(100V-240VAC), Output:full load
- Measuring is done by 20MHz bandwidth oscilloscope and terminated each output with a 10uF aluminum electrolytic capacitor and 0.1uF ceramic capacitor.

B) PROTECTION

01. Over voltage protection: protection zener
02. Short circuit protection: Output shut down and auto- recover
03. Over Load Protection: Output shut down and auto restart

C) SAFETY

01. HI-POT : Input to output : 3000VAC or 4242VDC 10mA 1 minute
02. Touch Current: <0.25mA @ 240Vac input voltage
03. Insulation resistance: Input to output: 500vdc to test the input to output resistance not be less 100M ohm

D) EMC

01. Emissions, per EN 55032, EN 61000-6-3, EN 61000-6-4
 - Conducted Emissions: Class B, FCC Part 15, Class B
 - Radiated Emissions: Class B, FCC Part 15, Class B
02. Line Frequency Harmonics EN61000-3-2, Class A
03. Voltage Fluctuations/Flicker EN61000-3-3
04. Immunity, per EN 55024, EN 61000-6-1, EN 61000-6-2
 - Static Discharge Immunity EN61000-4-2, 4kV Contact Discharge, 8kV air discharge
 - Radiated RF Immunity EN61000-4-3, 3V/m 80-1000MHz, 80% 1KHz AM.
 - EFT/Burst Immunity EN61000-4-4, 1kV/100kHz.
 - Line Surge Immunity EN61000-4-5, 1kV differential, 2kV common-mode
 - Conducted RF Immunity EN61000-4-6, 3Vrms, 80% 1KHz AM
 - Power Frequency Magnetic Field Immunity EN61000-4-8, 1A/m
 - Voltage Dip Immunity EN61000-4-11, Criteria

E) OTHER:

01. MTBF: 200,000 Hours @ 25°C ambient temperature
02. Operating Temperature: 0°C to 40°C ambient temperature
03. Humidity Operating : 20% to 80%. 0% to 90% relative humidity
04. Storage Temperature: -10°C to 70°C

PROPRIETARY INFORMATION

PROPRIETARY OF GLOBTEK, INC. ANY REPRODUCTION, DISCLOSURE OR USE OF THIS DRAWING, IN WHOLE OR IN PART, IS HEREBY PROHIBITED EXCEPT AS SPECIFIED IN WRITING BY GLOBTEK, INC.

<https://en.globtek.com/datasheet/id/a0Oa000000MFKlv>

Delivering leading edge, innovative power solutions for more than **30** years....

Model:GT-46200-20VV-x.x-T2

June 24, 2021

Humidity Storage: 10% to 90%

05. RoHS 2: Complies with EU 2011/65/EU and China SJ/T 11364-2014

F) ENCLOSURE

01. Housing: High impact plastic, 94V0 polycarbonate, non-vented

02. Size: 80.0 x 50.0 x 31.0 +/-1.0 mm

03. Markings: Label and/or Pad Printed and/or Molded in the case

Delivering leading edge, innovative power solutions for more than 30 years....

Model:GT-46200-20VV-x.x-T2

June 24, 2021

DERATING CURVE

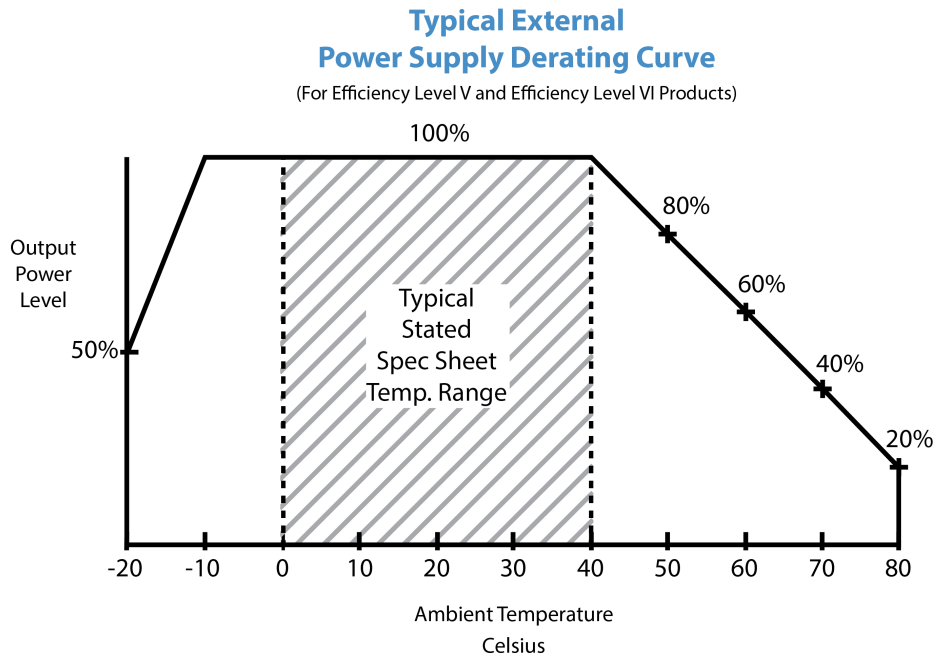

Delivering leading edge, innovative power solutions for more than 30 years....

Model:GT-46200-20VV-x.x-T2

June 24, 2021

INPUT CONFIGURATION

Description IEC 60320/C8 AC Inlet connector, Class II, Non-Earth Ground (aka "Figure-8")

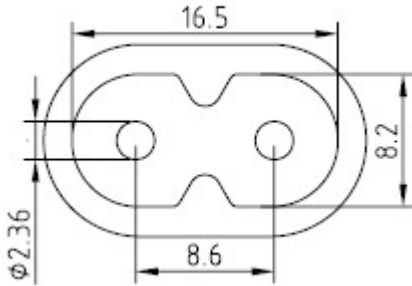

Mates with IEC 60320/C7 Plug

Below are standard cordsets which are "not included" (unless stated above); these may be purchased separately or packaged with the power supply. Please contact your Sales Engineer if the style required is not shown below. Many more available in different lengths, colors or cable material.

Standard International IEC 320/C7 Cordsets

| Part Number | Type | Standard | Connector | Length (mm) | Length (feet) |
|----------------------------------|------------------------|------------|------------|-------------|---------------|
| 2094112M703(R) | Argentina (Type I) | IRAM 2063 | IEC 320/C7 | 2000 | 7 |
| 5014112M703A(R) | Australian (Type I) | AS 3112 | IEC 320/C7 | 2000 | 7 |
| 207B4111M8703(R) | Brazil (Type N) | NBR14136 | IEC 320/C7 | 1800 | 6 |
| 4533501M8703(R) | China (Type A) | GB 2099.1 | IEC 320/C7 | 1830 | 6 |
| 2074112M703A(R) | European (Type C) | CEE 7/16 | IEC 320/C7 | 2000 | 7 |
| 2084111M8703B(R) | India (Type D) | IS 1293 | IEC 320/C7 | 1800 | 6 |
| 451J3401M8703(R) | Japan (Type A) | JIS 8303 | IEC 320/C7 | 1830 | 6 |
| 2044112M703A(R) | Korea (Type C) | KS C8305 | IEC 320/C7 | 2000 | 7 |
| 4511116F703A(R) | North America (Type A) | NEMA 1-15P | IEC 320/C7 | 1830 | 6 |
| | South Africa (Type | | | | |

Delivering leading edge, innovative power solutions for more than **30** years....

Model:GT-46200-20VV-x.x-T2

June 24, 2021

| | | | | | |
|----------------------------------|--|---------------|---------------|------|---|
| 2084111M8703(R) | M) | BS 546 | IEC320/C7 | 1830 | 6 |
| 4033401M8703A(R) | Taiwan (Type A) | CNS690 | IEC 320/C7 | 1830 | 6 |
| 6104112M703A(R) | UK, Hong Kong, Singapore, Gulf States (Type G) | BS1363 | IEC 320/C7 | 2000 | 7 |
| 451G1116F703A(R) | Gulf States (Kuwait, Bahrain, Oman, Qatar, Saudi Arabia, Yemen and the United Arab Emirates (UAE)(Type A) | Nema 1-15P | IEC320/C7 | 1830 | 6 |

Delivering leading edge, innovative power solutions for more than 30 years....

Model:GT-46200-20VV-x.x-T2

June 24, 2021

OUTPUT CONFIGURATION

Common output connector options:

 L Type (Coaxial
5.5x2.5mm plug)

 C Type (Coaxial
5.5x2.1mm plug)

 K Type (Coaxial
3.5x1.3mm plug)

 LL Type (5.5x2.5mm
Locking 760k type)

 CL Type (5.5x2.1mm
Locking S761k type)

 ML2 Type (Molex
housing 43025-0200)

 YL3 Type
(KPPX-3P)

YL4 Type (KPPX-4P)

 EJ1/2/3/4/5 (EIAJ
RC-5320A type
connectors)

 MSB Type (Micro
USB)

 USBC Type (USB
Type C)

 Inquire for custom
design

 For a comprehensive list of options, [click here](#)







Contact GlobTek for your specific requirements or custom solutions.

Delivering leading edge, innovative power solutions for more than 30 years....

Model:GT-46200-20VV-x.x-T2

June 24, 2021









Approvals

| Logo | Description |
|---|---|
| No Logo Applicable | EU 230V CoC Tier 2, 278/2009, Mar 2014 |
| No Logo Applicable | CB for IEC 62368-1:2014 (Second Edition) +A11:2017 |
|  | CCC to GB4943.1-2011; GB/T9254-2008 GB17625.1-2012, Tropical <2000 |
|  | CE Mark: tested to comply with EN55022:2006/A1:2007 Class B, EN610003-2, EN610003-3 including EN61000-4-2, EN61000-4-3, EN61000-4-4, EN61000-4-5, EN61000-4-6N EN61000-4-11; EMI: Complies with EN55011 CLASS B and FCC Part 15B - On label or Molded in case |
|  | CHINA SJ/T 11364-2014, China RoHS Chart: http://en.globtek.com/globtek-rohs.php |
| Conforms to UL STD. 62368-1 Certified to CSA STD C22.2 NO.62368-1 | Conforms to UL STD. 62368-1 Certified to CSA STD C22.2 NO.62368-1 |
|  | UL 60950-1, 2nd Edition, 2014-10-14 (Information Technology Equipment - Safety - Part 1: eneral Requirements) CAN/CSA C22.2 No. 60950-1-07, 2nd Edition, 2014-10 (Information Technology Equipment - Safety - Part 1: General Requirements) |
|  | |
|  | Declaration ДС № EAЭC N RU Д-US.KA01.B.10453_19 Custom Union of Russia, Belarus and Kazakhstan http://www.globtek.com/redirect/?loc=gost-certificate-eac-declaration |
| | IEC 60065 for Household Audio/Video Equipment |
|  | Indoor Use Only - Mark is on the label or Molded in the case |
| IP40 | Ingress Protection: ?IP40 to IEC60529:2001 Protection against granular foreign bodies (with I/P cord) |

Delivering leading edge, innovative power solutions for more than 30 years....

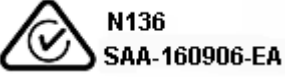
Model:GT-46200-20VV-x.x-T2



June 24, 2021

| | |
|---|--|
|  GlobTek, Inc. | JAPAN TUV R-PSE, Cert. No. JD 50473430, to J62368-1(H30) , J55032(H29),J3000(H25)[15V or less]. Please reference the following website for guidelines on PSE regulations: http://en.globtek.com/importing-ite-and-medical-power-supplies-ac-adaptors-to-japan/ |
| EFFICIENCY LEVEL  | Efficiency: complies to section 301 of Energy Independence and Security Act (EISA) complies with Energy Star tier 2 (North America), ECP tier 2 (China), MEPS tier 2 (Australia), Code of Conduct (Europe) |
| LPS | Limited Power Source 60950 |
|  | Morocco SDoC declaration http://www.globtek.info/certs/Morocco%20SDoC%20Declaration/ |
|  GlobTek, Inc. | JAPAN TUV Rheinland-PSE GlobTek Inc to J60950-1(H26) , J55022(H22),J3000(H25).Please follow the procedure listed in the following link for proper import to Japan: http://en.globtek.com/importing-to-japan.php . |
|  | RCM certificate SAA-160906-EA; Australia and New Zealand Regulatory Compliance, Mark http://rcm.standards.org.au/rcmfaq/rcmfaq.htm |
| RoHS | Specifications of directive 2011/65/EU Annex VI (ROHS-2) with amendment 2015/863-EU (ROHS-3) http://www.ce-mark.com/Rohs%20final.pdf |
|  | SIQ Mark EN 62368-1:2014 + All:2017 |
|  | UKCA Certification |
|  10276 | Ukraine UKRSepr (Document: www.globtek.com/html/iso_certificates/GT_Ukraine.pdf) |
| | |

Delivering leading edge, innovative power solutions for more than **30** years....

Model:GT-46200-20VV-x.x-T2

June 24, 2021

| | |
|---|--|
|  | UL 62368-1 and CAN/CSA C22.2 No. 62368-1-14 |
|  | Japan: Voluntary Control Council for Interference (VCCI) |
|  | WEEE: Complies with EU 2012/19/EU (http://ec.europa.eu/environment/waste/weee/index_en.htm) Mark is on the label or Molded in the case |