

Delivering leading edge, innovative power solutions for more than **30** years....

Model:GT-91114-06VV-P

August 17, 2022

GT-91114-06VV-P

Information

Model Number	GT-91114-06VV-P
Description	GT-91114-06VV-P, ICT/ITE Power Supply, Potted/Encapsulated in plastic housing, Regulated Switchmode AC-DC Power Supply AC Adaptor, , Input Rating: 100-240V~, 50-60 Hz, , Output Rating: 6 Watts, Power rating with convection cooling (W) , 3.3-48V in 0.1V increments, Approvals: WEEE; CE; China RoHS; RoHS; Double Insulation; Ukraine;
Model Picture	
Agency Documents	http://www.globtek.info/certs/GT-91114/
CE EC-Declaration	https://www.globtek.com/pdf/ec_declaration/a00a000000MghCEEAZ
RoHS/RoHS2 Declaration	https://www.globtek.com/pdf/rohs_cert/a00a000000MghCEEAZ
REACH Declaration	https://www.globtek.com/pdf/iso_certificates/REACH.pdf
Conflict Minerals Declaration	https://www.globtek.com/pdf/conflict-minerals.pdf

Delivering leading edge, innovative power solutions for more than **30** years....

Model:GT-91114-06VV-P

August 17, 2022

MODEL PARAMETERS

Type	Potted/Encapsulated in plastic housing
Technology	Regulated Switchmode AC-DC Power Supply AC Adaptor
Category	ICT/ITE Power Supply
Input Voltage	100-240V~, 50-60 Hz
I/P Amps (A)	0.6 A
Wattage (W)	6.0
Vout Range (V)	3.3-48
Efficiency Level	V
Ingress Protection	IP68
Size (mm)	55.4 x 24.8 x 23.5

Delivering leading edge, innovative power solutions for more than 30 years....

Model:GT-91114-06VV-P

August 17, 2022

ENCLOSURE

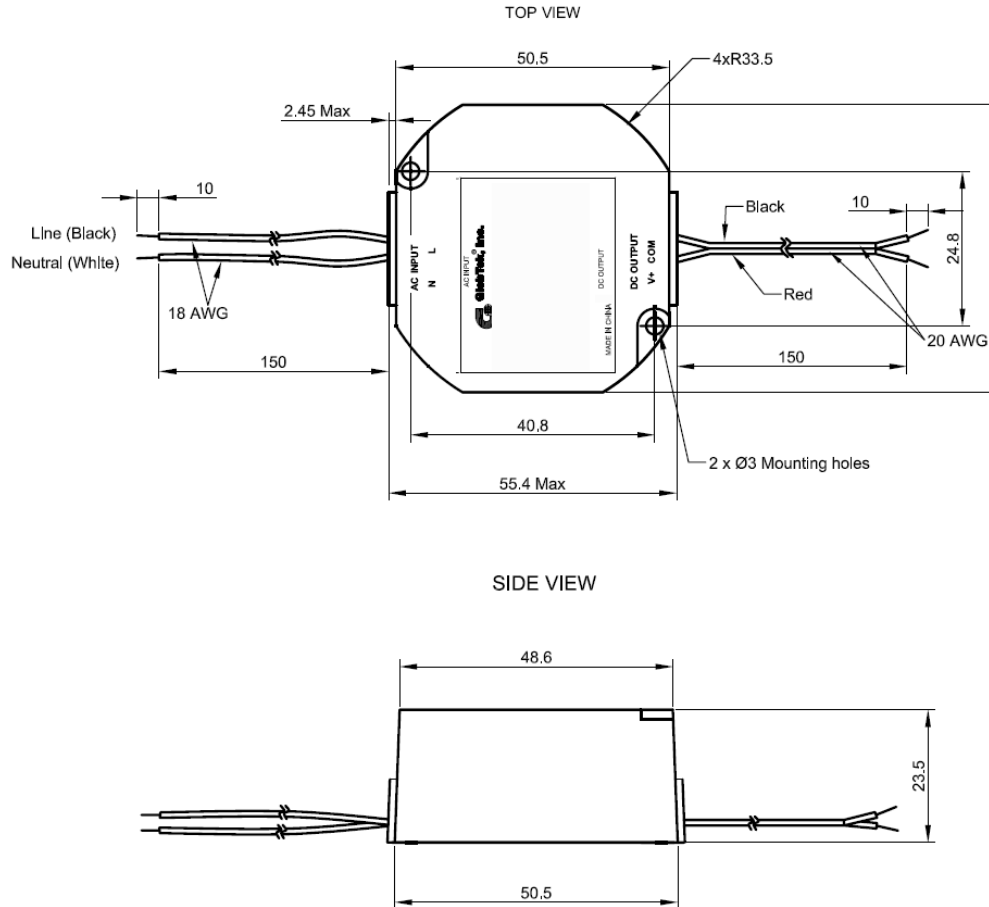

Delivering leading edge, innovative power solutions for more than **30** years....

Model:GT-91114-06VV-P

August 17, 2022

RATING TABLE

Model Number	Voltage	Amps(A)	Watts(W)	RFQ
GT-91114-0605-P	5 V	1.2	6.00	RFQ
GT-91114-0609-P	9 V	0.66	5.94	RFQ
GT-91114-0912-P	12 V	0.75	9.00	RFQ

Delivering leading edge, innovative power solutions for more than 30 years....

Model:GT-91114-06VV-P

August 17, 2022

SPECIFICATIONS

A) ELECTRICAL SPECIFICATIONS:

01. Input Voltage: Specified 90-264 Vac, Nameplate rated: 100-240Vac
02. Input Frequency: Specified 47-63 Hz, Nameplate rated 50-60Hz
03. Output Regulation: +/- 5% measured at the output connector
04. Line Voltage Regulation: +/- 5% typical measured at full load
05. Output Ripple (Vp-p): +/-1% or 50 mV whichever is greater, measured at 20 MHz bandwidth with 0.1 uf ceramic capacitor in parallel with 10 uf electrolytic capacitor connected at the end of the output connector at nominal line
06. Turn-ON/OFF Overshoot: 4% maximum, 500uS typical recovery time for 25% to 50% step load
07. Turn-ON Delay: 3000 mS, maximum @ full load, nominal line
08. Hold-Up Time: 8 mS typical @ nominal input voltage and full load
09. Inrush Current: 30A maximum cold start @ 240Vac input
10. Switching Frequency: 66.5 KHz typical
11. Efficiency: 75% Typically

B) PROTECTION

01. Over-Voltage: Electronically Protected via Zener Diode across output
02. Short Circuit: Electronically Protected via Hiccup unit will auto recover upon removal of fault
03. Input Protection: Input line fusing

C) SAFETY

01. Dielectric Withstand Voltage: 4242Vdc from primary to secondary
02. Touch Current: <0.25mA @ 240Vac input voltage

D) OTHER:

01. MTBF: 200,000 Hours @ 25°C ambient temperature
02. Operating Temperature: 0°C to 40°C ambient temperature
03. Humidity: 0% to 90% relative humidity
04. Storage Temperature: -40°C to 80°C
05. Cooling: Convection
06. ROHS 2: Complies with EU 2011/65/EU and China SJ/T 11363-2006

E) ENCLOSURE

01. Housing: High impact plastic, 94V0 polycarbonate, non-vented
02. Markings: Label and/or Pad Printed and/or Molded in the case
03. Enclosure dimensions: 55.4 x 52.0 x 23.5 mm
04. Ingress Protection: IP68

PROPRIETARY INFORMATION

PROPRIETARY OF GLOBTEK, INC. ANY REPRODUCTION, DISCLOSURE OR USE OF THIS DRAWING, IN WHOLE OR IN PART, IS HEREBY PROHIBITED EXCEPT AS SPECIFIED IN WRITING BY GLOBTEK, INC.

<https://www.globtek.com/datasheet/w71030>

Delivering leading edge, innovative power solutions for more than **30** years....

Model:GT-91114-06VV-P

August 17, 2022

DERATING CURVE

Delivering leading edge, innovative power solutions for more than **30** years....

Model:GT-91114-06VV-P

August 17, 2022

INPUT CONFIGURATION

Delivering leading edge, innovative power solutions for more than 30 years....

Model:GT-91114-06VV-P

August 17, 2022

OUTPUT CONFIGURATION

Common output connector options:

 L Type (Coaxial
5.5x2.5mm plug)

 C Type (Coaxial
5.5x2.1mm plug)

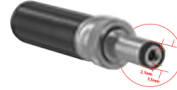
 K Type (Coaxial
3.5x1.3mm plug)

 LL Type (5.5x2.5mm
Locking 760k type)

 CL Type (5.5x2.1mm
Locking S761k type)

 ML2 Type (Molex
housing 43025-0200)

 YL3 Type
(KPPX-3P)

YL4 Type (KPPX-4P)

 EJ1/2/3/4/5 (EIAJ
RC-5320A type
connectors)

 MSB Type (Micro
USB)

 USBC Type (USB
Type C)

 Inquire for custom
design

 For a comprehensive list of options, [click here](#)





Contact GlobTek for your specific requirements or custom solutions.

Delivering leading edge, innovative power solutions for more than 30 years....

Model:GT-91114-06VV-P

August 17, 2022

Approvals

Logo	Description
	CE Mark: tested to comply with EN55022:2006/A1:2007 Class B, EN610003-2, EN610003-3 including EN61000-4-2, EN61000-4-3, EN61000-4-4, EN61000-4-5, EN61000-4-6N EN61000-4-11; EMI: Complies with EN55011 CLASS B and FCC Part 15B - On label or Molded in case
	CHINA SJ/T 11364-2014, China RoHS Chart: http://en.globtek.com/globtek-rohs.php
	
RoHS	Specifications of directive 2011/65/EU Annex VI (ROHS-2) with amendment 2015/863-EU (ROHS-3) http://www.ce-mark.com/Rohs%20final.pdf
 10276	Ukraine UKRSepro (Document: www.globtek.com/html/iso_certificates/GT_Ukraine.pdf)
	WEEE: Complies with EU 2012/19/EU (http://ec.europa.eu/environment/waste/weee/index_en.htm) Mark is on the label or Molded in the case