

Delivering leading edge, innovative power solutions for more than 30 years....

Model:GTM91120-30VV-P3 (SR with NA Plug 3 pin)

August 17, 2022

## GTM91120-30VV-P3 (SR with NA Plug 3 pin)

### Information

Model Number	GTM91120-30VV-P3 (SR with NA Plug 3 pin)
Description	GTM91120-30VV-P3 (SR with NA Plug 3 pin), Medical Power Supply, 60601-1-4th Ed. , Potted/Encapsulated in plastic housing, Regulated Switchmode AC-DC Power Supply AC Adaptor, , Input Rating: 100-240V~, 50-60 Hz, North America Blades with Ground Prong, Class I, (3) Conductors, Output Rating: 30 Watts, Power rating with convection cooling (W) , 5-48V in 0.1V increments, Approvals: UKCA; WEEE; VCCI; Ukraine; SIQ; SIQ; RoHS; PSE; Level V; IP68; IEC/EN60950-1; IEC/EN60601-1; IEC 60335; GOST-R; FCC; cRUus; cRUus (up to 30V); Class I; China RoHS; CE; CB EN/IEC 60335-1; CB 60950; CB 60601-1; Book 60601; Fuse 60335; CE; ETL; CB 60335;
Model Picture	
Agency Documents	<a href="http://www.globtek.info/certs/GTM91120-P2%20-P3/">http://www.globtek.info/certs/GTM91120-P2%20-P3/</a>
CE EC-Declaration	<a href="https://www.globtek.com/pdf/ec_declaration/a0Oa000000MgomaEAB">https://www.globtek.com/pdf/ec_declaration/a0Oa000000MgomaEAB</a>
RoHS/RoHS2 Declaration	<a href="https://www.globtek.com/pdf/rohs_cert/a0Oa000000MgomaEAB">https://www.globtek.com/pdf/rohs_cert/a0Oa000000MgomaEAB</a>
REACH Declaration	<a href="https://www.globtek.com/pdf/iso_certificates/REACH.pdf">https://www.globtek.com/pdf/iso_certificates/REACH.pdf</a>
Conflict Minerals Declaration	<a href="https://www.globtek.com/pdf/conflict-minerals.pdf">https://www.globtek.com/pdf/conflict-minerals.pdf</a>

Delivering leading edge, innovative power solutions for more than **30** years....

Model:GTM91120-30VV-P3 (SR with NA Plug 3 pin)

August 17, 2022

**MODEL PARAMETERS**

Type	Potted/Encapsulated in plastic housing
Technology	Regulated Switchmode AC-DC Power Supply AC Adaptor
Category	Medical Power Supply
Input Voltage	100-240V~, 50-60 Hz
I/P Amps (A)	1.5A
Wattage (W)	30.0
Vout Range (V)	5-48
Efficiency Level	V
Ingress Protection	IP68
Size (mm)	

Delivering leading edge, innovative power solutions for more than 30 years....

Model:GTM91120-30VV-P3 (SR with NA Plug 3 pin)

August 17, 2022

# ENCLOSURE

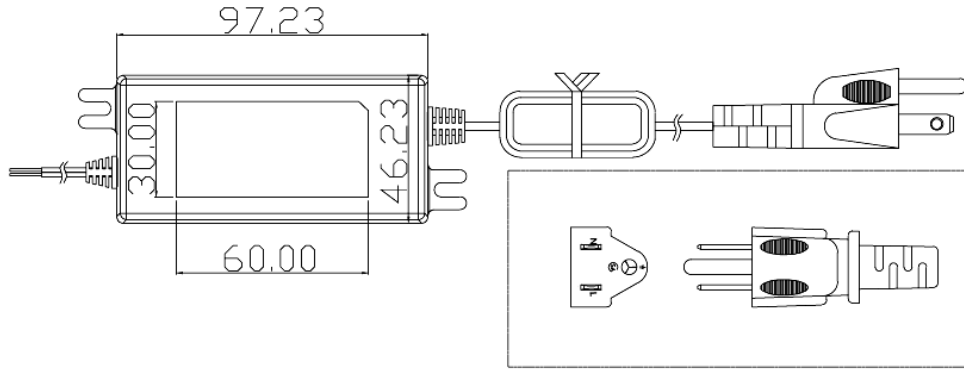

MYLAR CASE COVER INSTALLED



Delivering leading edge, innovative power solutions for more than **30** years....

Model:GTM91120-30VV-P3 (SR with NA Plug 3 pin)

August 17, 2022

## RATING TABLE

Model Number	Voltage	Amps(A)	Watts(W)	RFQ
--------------	---------	---------	----------	-----

Model:GTM91120-30VV-P3 (SR with NA Plug 3 pin)

August 17, 2022

## SPECIFICATIONS

### A) ELECTRICAL SPECIFICATIONS:

1. Input Voltage: Specified 90-264 Vac, Nameplate rated: 100-240Vac
2. Input Frequency: Specified 47-63 Hz, Nameplate rated 50-60Hz
3. Output power (rated): 30Watts max
4. Output Regulation: +/- 5% measured at the output connector
5. Line Voltage Regulation: +/- 2% typical measured at full load
6. Output Ripple (Vp-p): +/-2% maximum, measured at 20 MHz bandwidth with 0.1 uf ceramic capacitor in parallel with 10 uf electrolytic capacitor connected at the end of the output connector at nominal line  
Optional low ripple option available (RFP4579)
7. Turn-ON/OFF Overshoot: 5% maximum, 500uS typical recovery time for 25% to 50% step load
8. Turn-ON Delay: 3 Seconds, maximum @ full load, nominal line
9. Hold-Up Time: 5mS typical @ nominal input voltage and full load
10. Inrush Current: 60A maximum cold start @ 240Vac input
11. Switching Frequency: 100 KHz typical

### B) PROTECTION

1. Over-Voltage: Protected with a Zener diode clamp across the output
2. Short Circuit: Hiccup with auto recovery
3. Over-load: Hiccup with auto recovery
4. Input Protection: Input line and neutral fusing

### C) SAFETY

1. Dielectric Withstand Voltage: 5656Vdc from primary to secondary
2. Earth Leakage Current: Did not exceed 5 mA in NORMAL CONDITION and 10 mA in SINGLE FAULT CONDITION
3. Touch Current: Did not exceed 100uA NC(Normal condition) 500uA SFC(single fault condition)
4. Earth continuity test:<0.1 Ohm or < 0.2 Ohm when with a non-detachable Power Supply cord, Class I Only
5. MTBF: 200,000 hours @ 25°C ambient temperature
6. Operating Temperature: 0°C to 40°C ambient temperature
7. Humidity: 0% to 90% relative humidity
8. Storage Temperature: -10°C to 80°C
9. ROHS2: Complies with EU 2011/65/EU and China SJ/T 11363-2006

### D) OTHER:

1. MTBF: 200,000 Hours @ 25°C ambient temperature
2. Operating Temperature: 0°C to 40°C ambient temperature
3. Humidity: 0% to 90% relative humidity
4. Storage Temperature: -10°C to 80°C
5. Cooling: Convection
6. For EMI suppression 28A026-0A2 Snap-on Ferrites are recommended on both input and output cables, if required.

### E) ENCLOSURE

1. Housing: High impact plastic, 94V0 polycarbonate, non-vented
2. Size: 97.23 x 46.23 x 32.0 +/- 1.0 mm

#### PROPRIETARY INFORMATION

PROPRIETARY OF GLOBTEK, INC. ANY REPRODUCTION, DISCLOSURE OR USE OF THIS DRAWING, IN WHOLE OR IN PART, IS HEREBY PROHIBITED EXCEPT AS SPECIFIED IN WRITING BY GLOBTEK, INC.

<https://www.globtek.com/datasheet/w71033>

Delivering leading edge, innovative power solutions for more than **30** years....

Model:GTM91120-30VV-P3 (SR with NA Plug 3 pin)

August 17, 2022

3. Markings: Label and/or Pad Printed and/or Molded in the case

4. Ingress Protection: IP68, Dust Tight, No ingress of dust, complete protection against contact as well as Protected against liquid Immersion beyond 1 m

Delivering leading edge, innovative power solutions for more than **30** years....

Model:GTM91120-30VV-P3 (SR with NA Plug 3 pin)

August 17, 2022

## DERATING CURVE

---

Delivering leading edge, innovative power solutions for more than **30** years....

Model:GTM91120-30VV-P3 (SR with NA Plug 3 pin)

August 17, 2022

### INPUT CONFIGURATION

Description North America Blades with Ground Prong, Class I, (3) Conductors

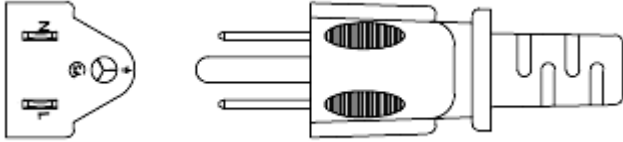



Delivering leading edge, innovative power solutions for more than 30 years....

Model:GTM91120-30VV-P3 (SR with NA Plug 3 pin)

August 17, 2022

**OUTPUT CONFIGURATION**

Common output connector options:



L Type (Coaxial 5.5x2.5mm plug)



C Type (Coaxial 5.5x2.1mm plug)



K Type (Coaxial 3.5x1.3mm plug)



LL Type (5.5x2.5mm Locking 760k type)



CL Type (5.5x2.1mm Locking S761k type)



ML2 Type (Molex housing 43025-0200)



YL3 Type (KPPX-3P)



YL4 Type (KPPX-4P)



EJ1/2/3/4/5 (EIAJ RC-5320A type connectors)



MSB Type (Micro USB)



USBC Type (USB Type C)



Inquire for custom design

For a comprehensive list of options, [click here](#)

Contact GlobTek for your specific requirements or custom solutions.

Delivering leading edge, innovative power solutions for more than **30** years....

Model:GTM91120-30VV-P3 (SR with NA Plug 3 pin)

August 17, 2022







## Approvals

Logo	Description
	Book 60335 up to 36 Volts
	60601-1 3rd Operating Instructions
No Logo Applicable	CB report IEC 60601-1: 2005 + CORR. 1 (2006) + CORR. 2 (2007) and or EN 60601-1:2006 3rd Edition including 2MOOP requirements
No Logo	CB Certificate IEC 60950-1:2005 (2nd Edition), Am 1: 2009, CB report IEC 60950-1:2005 (2nd Edition), Am 1: 2009 and EN 60950-1:2006 + Am 1:2010 + Am 11:2009 + Am 12:2011
No Logo Applicable	CB to 60335-1 5th Edition (Safety of Household and Similar Electrical Appliances, Part 1: General Requirements) CB Report/ Certificate IEC 60335-1:2010 Up to 36 volts only
No Logo Applicable	IEC 60335-1:2010 (Fifth Edition) incl. Corr. 1:2010 and Corr. 2:2011 + A1:2013
	CE Mark: tested to comply with EN 55032:2012+AC:2013, EN 61000-3-2:2014, EN 61000-3-3:2013, EN 55024:2010, EN 60601-1-2:2015
	CE Mark: tested to comply with EN61000-3-2, EN61000-3-3 and EN50082-1, including EN61000-4-2, EN61000-4-3, EN61000-4-4, EN61000-4-5, EN61000-4-6, EN61000-4-8, EN61000-4-11, EN61001-1-2-2007 EMI: Complies with EN55011 CLASS B and FCC Part 15 B
	AAMI ES60601-1:2005 +A1 - Medical Electrical Equipment - Part 1: General Requirements CAN/CSA-C22.2 No.60601-1:14, Third Edition Issued: 2014/03/01 - Medical Electrical Equipment - Part 1 IEC 60601-1-11 Issued: 2015/01/20 Ed. 2 Medical Elec. Equip.
	CHINA SJ/T 11364-2014, China RoHS Chart: <a href="http://en.globtek.com/globtek-rohs.php">http://en.globtek.com/globtek-rohs.php</a>
	Class I Earth Ground

Delivering leading edge, innovative power solutions for more than 30 years....

Model:GTM91120-30VV-P3 (SR with NA Plug 3 pin)



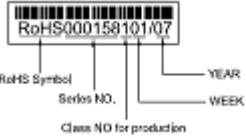



August 17, 2022

	cRUus Registered E170507 CSA C22.2 No. 60950-1 2nd Ed. (up to 30V)
	cRUus UL Recognized Component E172861 3rd Edition w-RM ANSI-AAMI ES60601-1 (2005 + C1:09 + A2:10) and CAN-CSA-C22.2 No. 60601-1 (2008)
	FCC PART 15 CLASS B
	GOST-R mark for Russia(Document: <a href="http://www.globtek.com/html/iso_certificates/GT_GOST-R.pdf">http://www.globtek.com/html/iso_certificates/GT_GOST-R.pdf</a> ). 03/15/2015. Due to lack of demand, GlobTek will not be renewing it's GOST certification. Please contact your sales engineer for pricing on EAC.
IEC/EN60335-1	IEC/EN60335-1 Up to 36 volts
IEC/EN60601-1	IEC/EN60601-1
IEC/EN60950-1	IEC/EN60950-1
	Indoor Use Only - Mark is on the label or Molded in the case
IP68	Ingress Protection: ?IP68 to IEC60529:2001 Totally dust tight and Protected against long periods of immersion under pressure
EFFICIENCY LEVEL 	Efficiency: complies to section 301 of Energy Independence and Security Act (EISA) complies with Energy Star tier 2 (North America), ECP tier 2 (China), MEPS tier 2 (Australia), Code of Conduct (Europe)
 Glob Tek, Inc.	JAPAN TUV Rheinland-PSE GlobTek Inc to J60950-1(H26) , J55022(H22),J3000(H25).Please follow the procedure listed in the following link for proper import to Japan: <a href="http://en.globtek.com/importing-to-japan.php">http://en.globtek.com/importing-to-japan.php</a> .
RoHS	Specifications of directive 2011/65/EU Annex VI (ROHS-2) with amendment 2015/863-EU (ROHS-3) <a href="http://www.ce-mark.com/Rohs%20final.pdf">http://www.ce-mark.com/Rohs%20final.pdf</a>
 <p>RoHS Symbol                  Series NO.                  Class NO for production                  YEAR                  WEEK</p>	Serial Number Information

Delivering leading edge, innovative power solutions for more than **30** years....

Model:GTM91120-30VV-P3 (SR with NA Plug 3 pin)

August 17, 2022

 IEC/EN60335-1	SIQ IEC/EN 60335-1 (Safety of Household and Similar Electrical Appliances, Part 1: General Requirements) up to 36 volts
 IEC/EN60601-1	SIQ Mark License EN60601-1, 3rd edition
	UKCA Certification
 10276	Ukraine UKRSePro (Document: <a href="http://www.globtek.com/html/iso_certificates/GT_Ukraine.pdf">www.globtek.com/html/iso_certificates/GT_Ukraine.pdf</a> )
	Japan: Voluntary Control Council for Interference (VCCI)
	WEEE: Complies with EU 2012/19/EU ( <a href="http://ec.europa.eu/environment/waste/weee/index_en.htm">http://ec.europa.eu/environment/waste/weee/index_en.htm</a> ) Mark is on the label or Molded in the case