

Delivering leading edge, innovative power solutions for more than 30 years....

Model:GT-46600-WWVV-X.X-T3

July 3, 2020

## Level VI Efficiency (EL6)[DOE EPS 2.0] Desktop Power Supply AC Adapter, 60w, output 12-24 VDC

### Information

#### Model Number

GT-46600-WWVV-X.X-T3

#### Description

GT-46600-WWVV-X.X-T3, ITE Power Supply, Desktop/External, Regulated Switchmode AC-DC Power Supply AC Adaptor, , Input Rating: 100-240V~, 50-60 Hz, IEC 60320/C14 AC Inlet Connector, Class I, Earth Ground, Output Rating: 60 Watts, Power rating with convection cooling (W) , 12-24V in 0.1V increments, Approvals: NOM (12V and 15V); South Africa; 230V CoC Tier 2; Saudi; Malaysia; Singapore (12V); Taiwan BSMI (12V and 15V); CB 60335; EAC; BIS; South Africa; CB 60950; NrCAN (12V and 15V); Morocco; CB 62368; FCC; IRAM; CE; CE; China RoHS; Class I; Level VI; LPS 60950;RoHS; Ukraine; VCCI; WEEE; cULus; PSE; PSE; CAN ICES-3; CCC; Korea (12V, 15V Only); SGS (GS); FCC; RCM;

#### Model Picture



#### Agency Documents

<http://www.globtek.info/certs/GT-46600-60VV-X.X/>

#### CE EC-Declaration

[https://www.globtek.com/pdf/ec\\_declaration/a00a000000Mia64EAB](https://www.globtek.com/pdf/ec_declaration/a00a000000Mia64EAB)

#### RoHS/RoHS2 Declaration

[https://www.globtek.com/pdf/rohs\\_cert/a00a000000Mia64EAB](https://www.globtek.com/pdf/rohs_cert/a00a000000Mia64EAB)

#### REACH Declaration

[https://www.globtek.com/pdf/iso\\_certificates/REACH.pdf](https://www.globtek.com/pdf/iso_certificates/REACH.pdf)

#### Conflict Minerals Declaration

<https://www.globtek.com/pdf/conflict-minerals.pdf>

Delivering leading edge, innovative power solutions for more than **30** years....

Model:GT-46600-WWVV-X.X-T3

July 3, 2020

**MODEL PARAMETERS**

Type	Desktop/External
Technology	Regulated Switchmode AC-DC Power Supply AC Adaptor
Category	ITE Power Supply
Input Voltage	100-240V~, 50-60 Hz
I/P Amps (A)	1.5A
Wattage (W)	60.0
Vout Range (V)	12-24
Efficiency Level	USA DOE Level VI / Eco-design Directive 2009/125/EC, (EU) 2019/1782
Ingress Protection	IPX0
Size (mm)	121*52*33

Delivering leading edge, innovative power solutions for more than **30** years....

Model:GT-46600-WWVV-X.X-T3

July 3, 2020

## ENCLOSURE

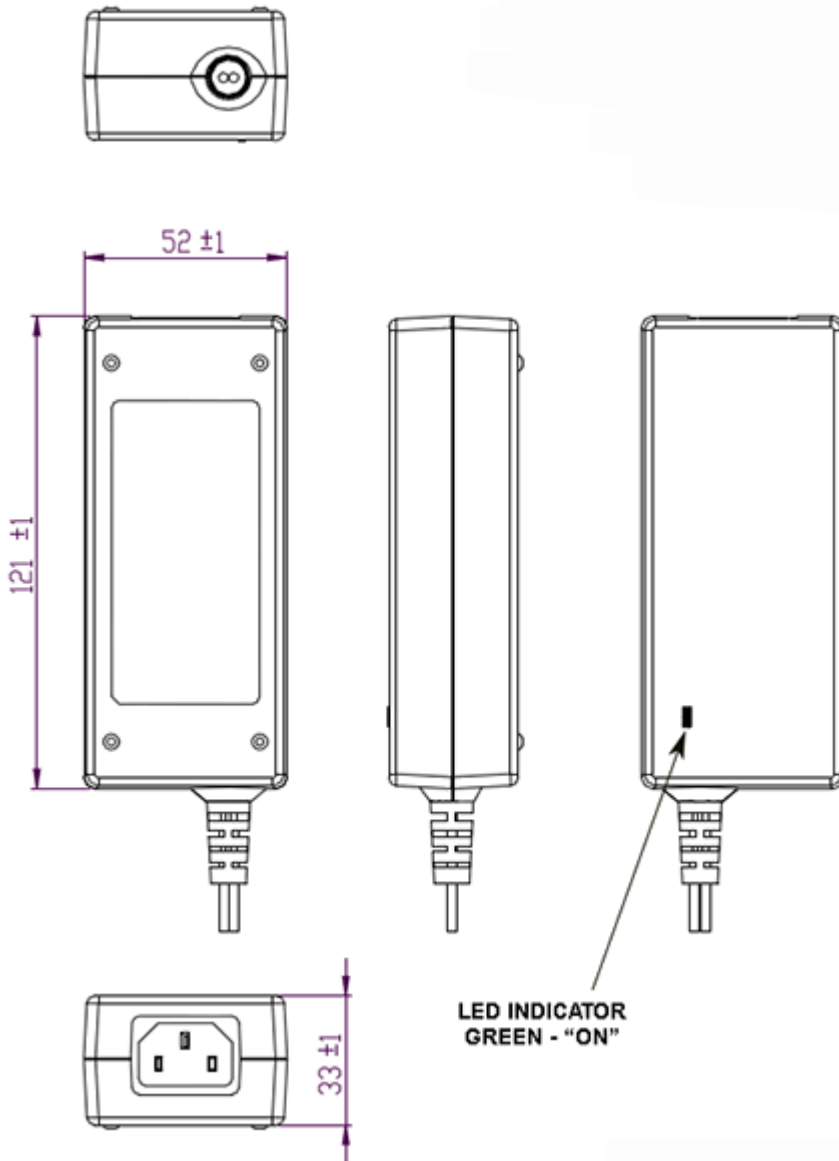

Delivering leading edge, innovative power solutions for more than **30** years....

Model:GT-46600-WWVV-X.X-T3

July 3, 2020

**RATING TABLE**

Model Number	Voltage	Amps(A)	Watts(W)	RFQ
GT-46600-6012-T3	12 V	5	60.00	<a href="#">RFQ</a>
GT-46600-3612-T3	12 V	3	36.00	<a href="#">RFQ</a>
GT-46600-6015-2.0-T3	13 V	4.61	59.93	<a href="#">RFQ</a>
GT-46600-6015-1.8-T3	13.2 V	4.54	59.93	<a href="#">RFQ</a>
GT-46600-6015-1.0-T3	14 V	4.28	59.92	<a href="#">RFQ</a>
GT-46600-6015-T3	15 V	4	60.00	<a href="#">RFQ</a>
GT-46600-6024-8.0-T3	16 V	3.75	60.00	<a href="#">RFQ</a>
GT-46600-6024-7.0-T3	17 V	3.52	59.84	<a href="#">RFQ</a>
GT-46600-6024-6.0-T3	18 V	3.33	59.94	<a href="#">RFQ</a>
GT-46600-6524-5.0-T3	19 V	3.42	64.98	<a href="#">RFQ</a>
GT-46600-6024-5.0-T3	19 V	3.15	59.85	<a href="#">RFQ</a>
GT-46600-6524-4.0-T3	20 V	3.25	65.00	<a href="#">RFQ</a>
GT-46600-6524-3.0-T3	21 V	3.09	64.89	<a href="#">RFQ</a>
GT-46600-6524-2.0-T3	22 V	2.95	64.90	<a href="#">RFQ</a>
GT-46600-6524-1.0-T3	23 V	2.62	60.26	<a href="#">RFQ</a>
GT-46600-6524-T3	24 V	2.7	64.80	<a href="#">RFQ</a>
GT-46600-6024-T3	24 V	2.5	60.00	<a href="#">RFQ</a>

Model:GT-46600-WWVV-X.X-T3

July 3, 2020

## SPECIFICATIONS

### A) ELECTRICAL SPECIFICATIONS:

01. Input Voltage: Specified 90-264 Vac, Nameplate rated: 100-240Vac
02. Input Frequency: Specified 47-63 Hz, Nameplate rated 50-60Hz
03. Input Rated Current: 1.5A RMS Max
04. Inrush Current: No damage at 240VAC Cold Start
05. Average Efficiency: 88% Min (CEC & DOE LEVEL VI Compliant); 89% Min (ErP Tier2 Compliant)
06. Input Power(no load): <0.21W (CEC &DOE Level VI Compliant); <0.15W (ErP Tier2 Compliant)
07. Output Regulation: +/- 5% measured at the output connector
08. Line regulation:  $\pm 1\%$
09. Ripple Voltage: 200mV (p-p) (100-240V AC Input). Measuring is done by 20MHz bandwidth oscilloscope and terminated each output with a 10uf aluminum electrolytic capacitor and 0.1uf ceramic capacitor.

### B) PROTECTION

01. Over-Voltage: Electronically Protected Zener clamp across the output
02. Short Circuit: Electronically Protected unit will auto recover upon removal of fault
03. Over Temperature Protection: There shall be no ignition or smoke and deformation of case
04. Over voltage protection: for 12V - 16V; for 15V - 20.25V, for 19V - 25.65, for 24V - 32.4V

### C) SAFETY

01. Dielectric Withstand Voltage: 4242Vdc from primary to secondary
02. Earth Leakage Current: <3.5 mA at 240Vac input voltage
03. Touch Current: <0.25mA @ 240Vac input voltage
04. ROHS 2: Complies with EU 2011/65/EU and China SJ/T 11363-2006
05. Earth continuity test:<0.1 Ohm or < 0.2 Ohm when with a non-detachable Power Supply cord, Class I Only

### D) OTHER:

01. MTBF: 1,500,000 hours @ 25°C ambient, full load (Telcordia SR-332, Issue 3)
02. Operating Temperature: 0°C to 40°C ambient temperature
03. Humidity: 10% to 90% relative humidity
04. Storage Temperature: -10°C to 70°C
05. Cooling: Convection
06. ROHS 2: Complies with EU 2011/65/EU and China SJ/T 11363-2006

### E) ENCLOSURE

01. Housing: High impact plastic, 94V0 polycarbonate, non-vented
02. Size: 121\*52\*33 +/-1.0 mm
03. Markings: Label and/or Pad Printed and/or Molded in the case

Delivering leading edge, innovative power solutions for more than 30 years....

Model:GT-46600-WWVV-X.X-T3

July 3, 2020

## DERATING CURVE

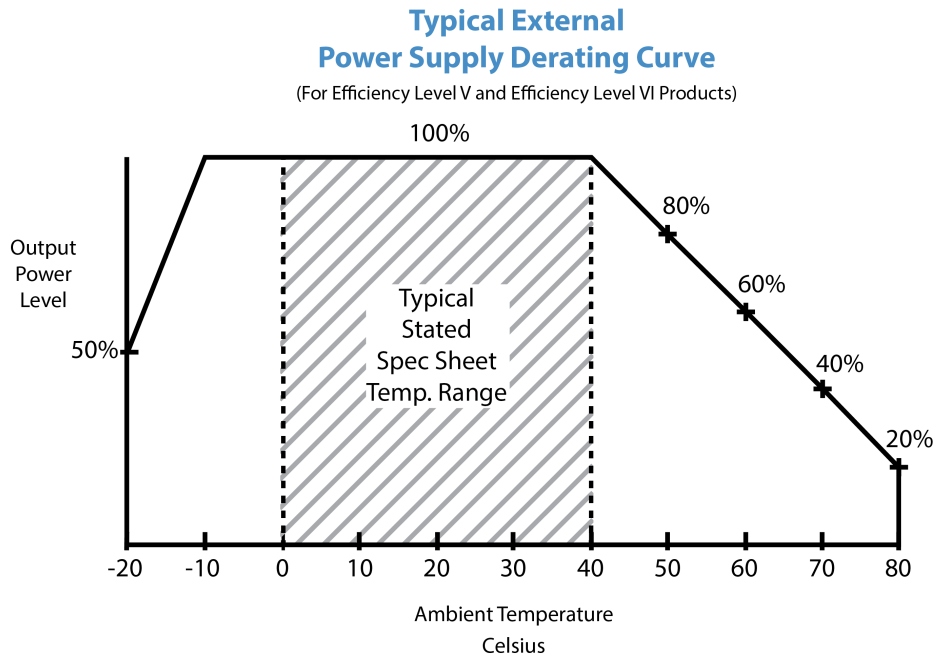

Delivering leading edge, innovative power solutions for more than 30 years....

Model:GT-46600-WWVV-X.X-T3

July 3, 2020

**INPUT CONFIGURATION**

Description IEC 60320/C14 AC Inlet Connector, Class I, Earth Ground

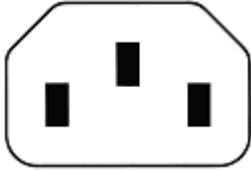

Mates with IEC 60320/C13 Plug

Optional Locking IEC60320 Receptacle and cord option available on some models by request.:

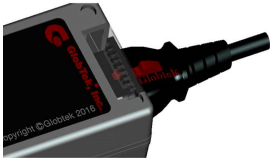
[Standard International IEC 320/C13 Cordsets](#)

Below are standard cordsets which are "not included" (unless stated above); these can be purchased separately or packaged with the power supply. Contact your Sales Engineer if the style required is not shown below. Many more available in different lengths, colors or cable material.

**Stock Power Supply Cords**

Part Number/ Link	Country	Plug	Termination	Length (mm)	(Ft)
<a href="#">3021457F701(R)</a>	N. American (Type B)	NEMA 5-15P	IEC 320/C13	2150	7
<a href="#">1191068F0701(R)</a>	N. American (Type B)	NEMA 5-15P Hospital	IEC 320/C13	2459	8
<a href="#">2194272M5701-T(R)</a>	Argentina (Type I)	IRAM 2073	IEC 320/C13	2500	8
<a href="#">5502022M5701A(R)</a>	Australian (Type I)	AS3112 / 3 PRONG	IEC 320/C13	2500	8
<a href="#">204B4272M5701(R)</a>	Brazil (Type N)	BRAZIL	IEC 320/C13	2500	8
<a href="#">6023602M5701(R)</a>	China (Type I)	CCC GR2099	IEC 320/C13	2500	8
<a href="#">G8014272M5701(R)</a>	Danish (Type K)	AFSNIT SECTION 107-2-D1	IEC 320/C13	2500	8
<a href="#">23144272M5701-T(R)</a>	Europe (Type E)	CEE 7/7	IEC 320/C13	2500	8
<a href="#">205IN4272M5701(R)</a>	India (Type D)	India IS 1293 (also known as IA16A3 or BS546)	IEC 320/C13	2500	8
<a href="#">208IN4272M5701(R)</a>	India (Type M)	India IS 1293 (also known as IA16A3 or BS546)	IEC320/C13	2500	8
<a href="#">377C4272M5701(R)</a>	Israel (Type H)	ISL 377C	IEC 320/C13	2500	8
<a href="#">23024272M5701(R)</a>	Italy (Type L)	CEI 23-16/VII	IEC 320/C13	2500	8
<a href="#">3003339F701(R)</a> [3x1.25mm2]	Japan (Type B)	JIS 8303 / 3 PINS	IEC 320/C13	2500	8

**PROPRIETARY INFORMATION**

PROPRIETARY OF GLOBTEK, INC. ANY REPRODUCTION, DISCLOSURE OR USE OF THIS DRAWING, IN WHOLE OR IN PART, IS HEREBY PROHIBITED EXCEPT AS SPECIFIED IN WRITING BY GLOBTEK, INC.

<http://en.globtek.com/datasheet/id/a00a000000Mia64>

Delivering leading edge, innovative power solutions for more than **30** years....

Model:GT-46600-WWVV-X.X-T3

July 3, 2020

<a href="#">3003068F2701-HK(R)</a> [3 x 2.0mm2]					
<a href="#">302J115J6F0701J(R)</a>	Japan / North America (Type B – 12A)	JIS 8303 / 3 PINS and NEMA 5-15P (PSE and UL/CUL appr)	IEC 320/C13	1830	6
<a href="#">302J104J6F0701J(R)</a>	Japan / North America (Type B – 15A)	JIS 8303 / 3 PINS and NEMA 5-15P (PSE and UL/CUL appr)	IEC 320/C13	1830	6
<a href="#">2313K3432M5701(R)</a>	Korea (Type F)	KS C 8305	IEC 320/C13	2500	8
<a href="#">5804272M5701(R)</a>	Russia (Type F)	GOST 7396	IEC 320/C13	2500	8
<a href="#">2084272M5701(R)</a>	South Africa (Type M)	South Africa SABS164-1 (16A type)	IEC 320/C13	2500	8
<a href="#">23214272M5701(R)</a>	Switzerland (Type J)	SEV 1011	IEC 320/C13	2500	8
<a href="#">3003322M5701(R)</a>	Taiwan (Type B)	BSMI	IEC 320/C13	2500	8
<a href="#">PZ0800100-2M5BK13H(R)</a>	UK, Hong Kong, Singapore, Gulf States (Type G)	BS 1363A	IEC 320/C13	2500	8
<a href="#">7055002M5701A(R)</a>	International	IEC 320 C14-C13	IEC 320/C13	2500	8



Delivering leading edge, innovative power solutions for more than 30 years....

Model:GT-46600-WWVV-X.X-T3

July 3, 2020

**OUTPUT CONFIGURATION**

Common output connector options:

 L Type (Coaxial  
5.5x2.5mm plug)

 C Type (Coaxial  
5.5x2.1mm plug)

 K Type (Coaxial  
3.5x1.3mm plug)

 LL Type (5.5x2.5mm  
Locking 760k type)

 CL Type (5.5x2.1mm  
Locking S761k type)

 ML2 Type (Molex  
housing 43025-0200)

 YL3 Type  
(KPPX-3P)

YL4 Type (KPPX-4P)

 EJ1/2/3/4/5 (EIAJ  
RC-5320A type  
connectors)

 MSB Type (Micro  
USB)

 USBC Type (USB  
Type C)

 Inquire for custom  
design

 For a comprehensive list of options, [click here](#)

Contact GlobTek for your specific requirements or custom solutions.

Delivering leading edge, innovative power solutions for more than 30 years....

Model:GT-46600-WWVV-X.X-T3

July 3, 2020









## Approvals

Logo	Description
No Logo Applicable	EU 230V CoC Tier 2, 278/2009, Mar 2014
	Bureau Of Indian Standards for: GT-46181-0809-3.8-T3, 1209-3.05-T3, 1505-T3, 1605-T3, 1805-T3, 1809-3.05-T3, 1809-T3, 1812-2.0-T3-I812-T3, 1815-T3 GT-46600-6012-T3, 6012-T3A, 6015-1.8-T3, 6015-T3, 6015-T3A, 6024-5.0-T3, 6024-6.0-T3, 6024-T3, 6524-5.0, 6524-T3
	Taiwan BSMI; <a href="http://www.bsmi.gov.tw/wSite/ct?xItem=4072&amp;ctNode=8167=2">http://www.bsmi.gov.tw/wSite/ct?xItem=4072&amp;ctNode=8167=2</a> GT-46600-6012-T3, GT-46600-6015-1.82-T3, GT-46600-6015-1.8-T3A, GT-46600-6015-T3, GT-46600-6012-T3A
No Logo Applicable	IEC 60335-1:2010+A1+A2
No Logo Applicable	IEC 60950-1:2005 +A1:2009 +A2:2013
No Logo Applicable	CB for IEC 62368-1:2014 (Second Edition)
	CCC to GB4943.1-2011; GB/T9254-2008 GB17625.1-2012, Tropical <2000
	CE Certification Class II CE Mark: tested to comply with EN 55032.2012+AC.2013 EN 61000-3-2.2014 EN 61000-3-3.2013 EN 55024.2010
	CE Mark: tested to comply with EN55022:2006/A1:2007 Class B, EN610003-2, EN610003-3 including EN61000-4-2, EN61000-4-3, EN61000-4-4, EN61000-4-5, EN61000-4-6N EN61000-4-11; EMI: Complies with EN55011 CLASS B and FCC Part

Delivering leading edge, innovative power solutions for more than 30 years....

Model:GT-46600-WWVV-X.X-T3







July 3, 2020

	<p>15B - On label or Molded in case</p> <p>CHINA SJ/T 11364-2014, China RoHS Chart: <a href="http://en.globtek.com/globtek-rohs.php">http://en.globtek.com/globtek-rohs.php</a></p>
	<p>UL60950-1, cULus to UL 60950-1, 2nd Edition, 2007-03-27 and CSA C22.2 No. 60950-1-07, 2nd Edition, 2007-03</p>
	<p>Declaration ДС № EAЭC N RU Д-US.KA01.B.10453_19 Custom Union of Russia, Belarus and Kazakhstan <a href="http://www.globtek.com/redirect/?loc=gost-certificate-eac-declaration">http://www.globtek.com/redirect/?loc=gost-certificate-eac-declaration</a></p>
<p>No Logo</p>	<p>Greenhouse and Energy Minimum Standards (GEMS) for model GT-46600-6012-T3 Registration No APS4053</p>
	<p>Compliance of this power supply with FCC Part 15, Class B has been demonstrated with a standard output load. The FCC law stipulates that system-level testing is required to demonstrate compliance with the FCC emission limits with the actual system load.</p>
<p>CAN ICES-3(B)/NMB-3(B)</p>	<p>Compliance of this PSU with Industry Canada, Class B demonstrated with a standard output load. The ICES law stipulates that system-level testing is required to demonstrate compliance with the ICES-3 emission limits with the actual system load.</p>
	<p>Indoor Use Only - Mark is on the label or Molded in the case</p>
 <b>DC-E-G71-002.8</b> PRECAUCION: PARA USO EN EQUIPOS ELECTRONICOS SOLAMENTE	<p>IRAM certificate DC-E-G71-002.8 to IEC 60950-1:2005 + A1:2009 +A2:2013 for 12V and 15V</p>
 GlobTek, Inc.	<p>JAPAN TUV R-PSE, Cert. No. JD 50469658, to J62368-1(H30) , J55032(H29),J3000(H25)[15V or less]. Please reference the following website for guidelines on PSE regulations: <a href="http://en.globtek.com/importing-ite-and-medical-power-supplies-ac-adaptors-to-japan/">http://en.globtek.com/importing-ite-and-medical-power-supplies-ac-adaptors-to-japan/</a></p>
 GlobTek, Inc.	<p>JAPAN TUV R-PSE, Cert. No. JD 50469658, to J62368-1(H30) , J55032(H29),J3000(H25)[DC15?30V]. Please reference the following website for guidelines on PSE regulations: <a href="http://en.globtek.com/importing-ite-and-medical-power-supplies-ac-adaptors-to-japan/">http://en.globtek.com/importing-ite-and-medical-power-supplies-ac-adaptors-to-japan/</a></p>

Delivering leading edge, innovative power solutions for more than **30** years....

Model:GT-46600-WVVV-X.X-T3







July 3, 2020

 직류전원장치 AC/DC ADAPTER KTC HU10499-16027A KCC-REM-GSZ-46600-6012-T3 전기용품안전관리법에 의한 표시 최저소비효율기준 만족 제품 모델명:GT-46600-6012-T3 Mfr. Name: GLOBTEK (SUZHOU) CO.,LTD A/S Center:10-6221-6100	Korea KET KC Mark GT-46600-6012-T3 HU10499-16027A (12V, 15V Only)
EFFICIENCY LEVEL 	Efficiency: complies to section 301 of Energy Independence and Security Act (EISA) complies with Energy Star tier 2 (North America), ECP tier 2 (China), MEPS tier 2 (Australia), Code of Conduct (Europe)
LPS	Limited Power Source 60950
No Logo	Malaysia ST Release Letter GT-46600 T2 -T3A IEC60950-1(Ed.2): 2005 + A1:2009 + A2:2013 No logo
	Morocco SDoC declaration <a href="http://www.globtek.info/certs/Morocco%20SDoC%20Declaration/">http://www.globtek.info/certs/Morocco%20SDoC%20Declaration/</a>
	NOM (Mexico) to NOM-001-SCFI-1993 GT-46600-6012 (6015) -T3 for 12V and 15V
	NRCAN Nemko for GT-46600-6012 (12V output) and GT-46600-6015 (15V output) only Natural Resources Canada (NRCAN): CSA Standard C381.1-08, QSP NRCAN EEV1191; <a href="http://shop.csa.ca/en/canada/energy-efficiency/canicsa-c3811-08/inv/27024802008">http://shop.csa.ca/en/canada/energy-efficiency/canicsa-c3811-08/inv/27024802008</a>
 <b>SAA-161532-EA</b>	RCM certificate SAA-161532-EA; Australia and New Zealand Regulatory Compliance, Mark ( <a href="http://rcm.standards.org.au/rcmfaq/rcmfaq.htm">http://rcm.standards.org.au/rcmfaq/rcmfaq.htm</a> )
RoHS	Specifications of directive 2011/65/EU Annex VI (ROHS-2) with amendment 2015/863-EU (ROHS-3) <a href="http://www.ce-mark.com/Rohs%20final.pdf">http://www.ce-mark.com/Rohs%20final.pdf</a>

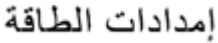
Delivering leading edge, innovative power solutions for more than **30** years....

Model:GT-46600-WWVV-X.X-T3

July 3, 2020

	Saudi Arabia approval GT-46600-60VV-X.X-T3 IEC 60950-2005 (output voltage range is 12-24V)
	SGS GS to EN 60950-1:2006 + A11:2009+A1:2010+A12:2011+A2:2013 AFPS GS 2014:01 PAK
	Singapore to IEC 60950-1:2005 + A1:2009 + A2:2013 (for 12V only)
No Logo	South Africa EMI and EMC approval to CISPR 22 Class B CISPR 24
No Logo	South Africa approval to SANS IEC 60950
	Ukraine UKRSepro (Document: <a href="http://www.globtek.com/html/iso_certificates/GT_Ukraine.pdf">www.globtek.com/html/iso_certificates/GT_Ukraine.pdf</a> )
	Japan: Voluntary Control Council for Interference (VCCI)
	WEEE: Complies with EU 2012/19/EU ( <a href="http://ec.europa.eu/environment/waste/weee/index_en.htm">http://ec.europa.eu/environment/waste/weee/index_en.htm</a> ) Mark is on the label or Molded in the case