

Delivering leading edge, innovative power solutions for more than 30 years....

Model:GTM91099-60VV-P3(SR with NA Plug 3 pin)

November 27, 2020

## GTM91099-60VV-P3(SR with NA Plug 3 pin)

### Information

Model Number

GTM91099-60VV-P3(SR with NA Plug 3 pin)

Description

GTM91099-60VV-P3(SR with NA Plug 3 pin), ITE / Medical Power Supply, 60601-1-4th Ed. , Potted/Encapsulated in plastic housing, Regulated Switchmode AC-DC Power Supply AC Adaptor, , Input Rating: 100-240V~, 50-60 Hz, North America Blades with Ground Prong, Class I, (3) Conductors, Output Rating: 60 Watts, Power rating with convection cooling (W) , 5-48V in 0.1V increments, Approvals: ETL; S-Mark IEC/EN 60601-1 60950; EAC; Book 60601; CB 60601-1 2MOPP; CB 60950; China RoHS; Class I; IEC/EN60601-1; IEC/EN60950-1; IP68; Level V; LPS 60950; NEMKO 60950; PSE; RoHS; Ukraine; VCCI; WEEE; cRUus;

Model Picture



Agency Documents

<http://www.globtek.info/certs/GTM91099/>

CE EC-Declaration

[https://www.globtek.com/pdf/ec\\_declaration/a0Oa000000Mj1aJEAR](https://www.globtek.com/pdf/ec_declaration/a0Oa000000Mj1aJEAR)

RoHS/RoHS2 Declaration

[https://www.globtek.com/pdf/rohs\\_cert/a0Oa000000Mj1aJEAR](https://www.globtek.com/pdf/rohs_cert/a0Oa000000Mj1aJEAR)

REACH Declaration

[https://www.globtek.com/pdf/iso\\_certificates/REACH.pdf](https://www.globtek.com/pdf/iso_certificates/REACH.pdf)

Conflict Minerals Declaration

<https://www.globtek.com/pdf/conflict-minerals.pdf>

Delivering leading edge, innovative power solutions for more than **30** years....

Model:GTM91099-60VV-P3(SR with NA Plug 3 pin)

November 27, 2020

**MODEL PARAMETERS**

Type	Potted/Encapsulated in plastic housing
Technology	Regulated Switchmode AC-DC Power Supply AC Adaptor
Category	ITE / Medical Power Supply
Input Voltage	100-240V~, 50-60 Hz
I/P Amps (A)	1.5A
Wattage (W)	60.0
Vout Range (V)	5-48
Efficiency Level	V
Ingress Protection	
Size (mm)	

Delivering leading edge, innovative power solutions for more than 30 years....

Model:GTM91099-60VV-P3(SR with NA Plug 3 pin)

November 27, 2020

## ENCLOSURE

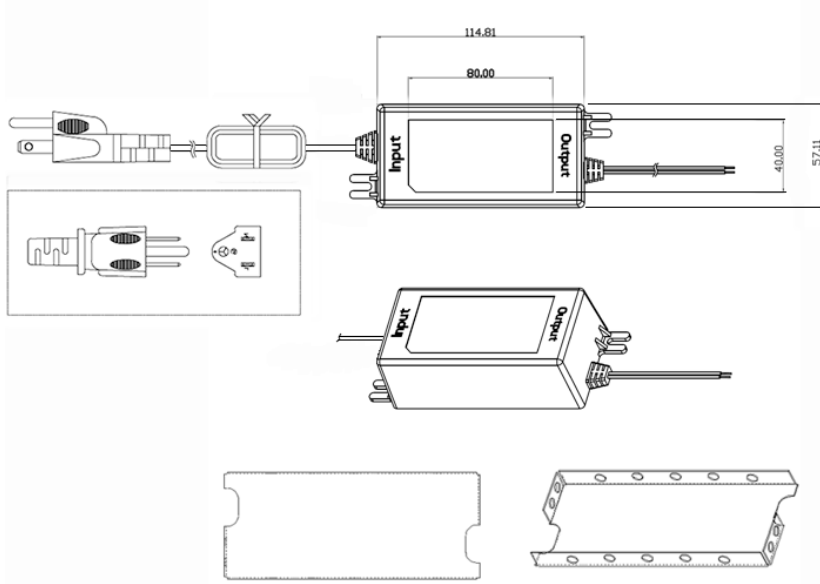

MYLAR CASE COVER INSTALLED

Delivering leading edge, innovative power solutions for more than **30** years....

Model:GTM91099-60VV-P3(SR with NA Plug 3 pin)

November 27, 2020

## RATING TABLE

Model Number	Voltage	Amps(A)	Watts(W)	RFQ
--------------	---------	---------	----------	-----

Delivering leading edge, innovative power solutions for more than 30 years....

Model:GTM91099-60VV-P3(SR with NA Plug 3 pin)

November 27, 2020

## SPECIFICATIONS

### A) ELECTRICAL SPECIFICATIONS:

01. Input Voltage: Specified 90-264 Vac, Nameplate rated: 100-240Vac
02. Input Frequency: Specified 47-63 Hz, Nameplate rated 50-60Hz
03. Output Regulation: +/- 5% measured at the output connector
04. Line Voltage Regulation: +/- 2% typical measured at full load
05. Output Ripple (Vp-p): +/-1% or 150 mV whichever is greater, measured at 20 MHz bandwidth with 0.1 uf ceramic capacitor in parallel with 10 uf electrolytic capacitor connected at the end of the output connector at nominal line
06. Turn-ON/OFF Overshoot: 5% maximum, 0.5 mS typical recovery time for 25% to 50% step load
07. Turn-ON Delay: 2 S, maximum @ full load, nominal line
08. Hold-Up Time: 8 mS typical @ nominal input voltage and full load
09. Inrush Current: 40A maximum cold start @ 240Vac input
10. Switching Frequency: 100 KHz typical

### B) PROTECTION

01. Over-Voltage: Protected, HICCUP with auto recovery
02. Over Load: Protected, HICCUP with auto recovery
02. Short Circuit: Protected, HICCUP with auto recovery
03. Input Protection: Input and neutral line fusing

### C) SAFETY

01. Dielectric Withstand Voltage: 5656Vdc from primary to secondary
02. Earth Leakage Current: Did not exceed 5 mA in NORMAL CONDITION and 10 mA in SINGLE FAULT CONDITION
03. Touch Current: Did not exceed 100uA NC(Normal condition) 500uA SFC(single fault condition)
04. Earth continuity test: <0.1 Ohm or < 0.2 Ohm when with a non-detachable Power Supply cord, Class I Only
05. ROHS 2: Complies with EU 2011/65/EU and China SJ/T 11363-2006

### D) OTHER:

01. MTBF: 200,000 Hours @ 25°C ambient temperature
02. Operating Temperature: -30°C to 55°C ambient temperature
03. Humidity: 0% to 90% relative humidity
04. Storage Temperature: -10°C to 80°C
05. Cooling: Convection

### E) ENCLOSURE

01. Housing: High impact plastic, 94V0 polycarbonate, non-vented
02. Size: 114.81 x 57.11x 33.0 +/-1.0 mm
03. Markings: Label and/or Pad Printed and/or Molded in the case

#### PROPRIETARY INFORMATION

PROPRIETARY OF GLOBTEK, INC. ANY REPRODUCTION, DISCLOSURE OR USE OF THIS DRAWING, IN WHOLE OR IN PART, IS HEREBY PROHIBITED EXCEPT AS SPECIFIED IN WRITING BY GLOBTEK, INC.

<http://en.globtek.com/datasheet/id/a0Oa000000Mj1aJ>

Delivering leading edge, innovative power solutions for more than **30** years....

Model:GTM91099-60VV-P3(SR with NA Plug 3 pin)

November 27, 2020

### DERATING CURVE

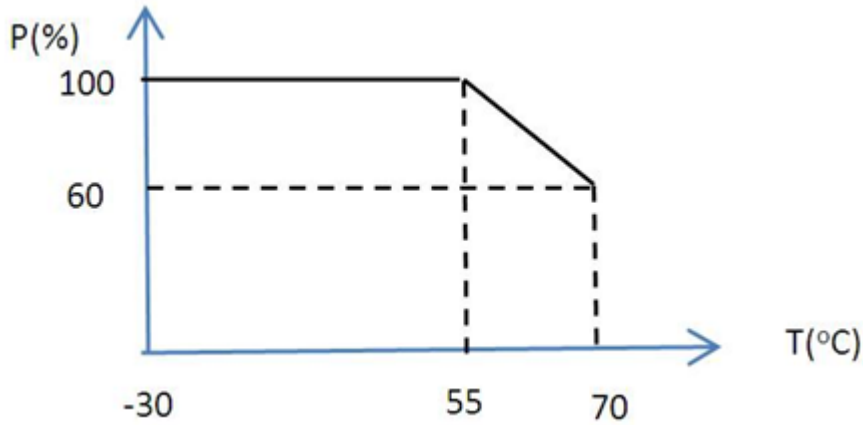

Delivering leading edge, innovative power solutions for more than **30** years....

Model:GTM91099-60VV-P3(SR with NA Plug 3 pin)

November 27, 2020

### INPUT CONFIGURATION

Description North America Blades with Ground Prong, Class I, (3) Conductors

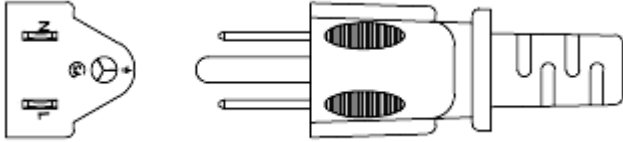

Delivering leading edge, innovative power solutions for more than 30 years....

Model:GTM91099-60VV-P3(SR with NA Plug 3 pin)

November 27, 2020

**OUTPUT CONFIGURATION**

Common output connector options:

 L Type (Coaxial  
5.5x2.5mm plug)

 C Type (Coaxial  
5.5x2.1mm plug)

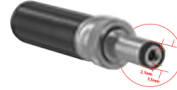
 K Type (Coaxial  
3.5x1.3mm plug)

 LL Type (5.5x2.5mm  
Locking 760k type)

 CL Type (5.5x2.1mm  
Locking S761k type)

 ML2 Type (Molex  
housing 43025-0200)

 YL3 Type  
(KPPX-3P)

YL4 Type (KPPX-4P)

 EJ1/2/3/4/5 (EIAJ  
RC-5320A type  
connectors)

 MSB Type (Micro  
USB)

 USBC Type (USB  
Type C)

 Inquire for custom  
design

 For a comprehensive list of options, [click here](#)

Contact GlobTek for your specific requirements or custom solutions.









Delivering leading edge, innovative power solutions for more than 30 years....

Model:GTM91099-60VV-P3(SR with NA Plug 3 pin)

November 27, 2020









## Approvals

Logo	Description
	Attention Mark / Refer to operating manual for operating and service instructions
	60601-1 3rd Operating Instructions
No Logo Applicable	CB report IEC 60601-1: 2005 + CORR. 1 (2006) + CORR. 2 (2007) and or EN 60601-1:2006 3rd Edition 2xMOPP
No Logo	CB Certificate IEC 60950-1:2005 (2nd Edition), Am 1: 2009, CB report IEC 60950-1:2005 (2nd Edition), Am 1: 2009 and EN 60950-1:2006 + Am 1:2010 + Am 11:2009 + Am 12:2011
	CHINA SJ/T 11364-2014, China RoHS Chart: <a href="http://en.globtek.com/globtek-rohs.php">http://en.globtek.com/globtek-rohs.php</a>
	Class I Earth Ground
	cRUus UL Recognized Component E172861 3rd Edition and UL 60950-1 w-RM ANSI-AAMI ES60601-1 (2005 + C1:09 + A2:10) and CAN-CSA-C22.2 No. 60601-1 (2008)
	Certification # TC RU C-US.AR46.B.79113 Custom Union of Russia, Belarus and Kazakhstan
	Medical Electrical Equipment – Part 1: General Requirement for Basic safety Essential Performance (AAMI ES60601-1:2005+A1) Medical Electrical Equipment – Part 1: General Requirement for Basic safety Essential Performance (CSA C22 2#60601-1:2014 Ed.3)
IEC/EN60601-1	IEC/EN60601-1
IEC/EN60950-1	IEC/EN60950-1

Delivering leading edge, innovative power solutions for more than **30** years....

Model:GTM91099-60VV-P3(SR with NA Plug 3 pin)

November 27, 2020

	Indoor Use Only - Mark is on the label or Molded in the case
IP68	Ingress Protection: ?IP68 to IEC60529:2001 Totally dust tight and Protected against long periods of immersion under pressure
<b>EFFICIENCY LEVEL</b> 	Efficiency: complies to section 301 of Energy Independence and Security Act (EISA) complies with Energy Star tier 2 (North America), ECP tier 2 (China), MEPS tier 2 (Australia), Code of Conduct (Europe)
LPS	Limited Power Source 60950
 Apparatet må tilkoples jordet stikkontakt	Nemko w Class I Warning Nemko EN60950-1:2006, A11, A1, A12
 GlobTek, Inc.	JAPAN TUV Rheinland-PSE GlobTek Inc to J60950-1(H26) , J55022(H22),J3000(H25).Please follow the procedure listed in the following link for proper import to Japan: <a href="http://en.globtek.com/importing-to-japan.php">http://en.globtek.com/importing-to-japan.php</a> .
RoHS	Specifications of directive 2011/65/EU Annex VI (ROHS-2) with amendment 2015/863-EU (ROHS-3) <a href="http://www.ce-mark.com/Rohs%20final.pdf">http://www.ce-mark.com/Rohs%20final.pdf</a>
 Intertek IEC/EN60601-1 IEC/EN60950-1	Semko S-Mark-Cert-EN60601-1 and EN60950-1
 RoHS Symbol Serial NO. Class NO for production YEAR WEEK	Serial Number Information
 10278	Ukraine UKRSepto (Document: <a href="http://www.globtek.com/html/iso_certificates/GT_Ukraine.pdf">www.globtek.com/html/iso_certificates/GT_Ukraine.pdf</a> )
	Japan: Voluntary Control Council for Interference (VCCI)
	WEEE: Complies with EU 2012/19/EU (

Delivering leading edge, innovative power solutions for more than **30** years....

Model:GTM91099-60VV-P3(SR with NA Plug 3 pin)

November 27, 2020

	<p><a href="http://ec.europa.eu/environment/waste/weee/index_en.htm">http://ec.europa.eu/environment/waste/weee/index_en.htm</a> Mark is on the label or Molded in the case</p>
---	---