

Delivering leading edge, innovative power solutions for more than 30 years....

Model:GT-86120-WWVV (G-Blade)

April 10, 2020

## GT-86120-WWVV (G-Blade)

### Information

Model Number	GT-86120-WWVV (G-Blade)
Description	GT-86120-WWVV (G-Blade), ITE Power Supply, Wall Plug-in, Regulated Switchmode AC-DC Power Supply AC Adaptor, , Input Rating: 100-240V~, 50-60Hz, Blade Options for G- Series Wall Plug-in Power Supplies, Output Rating: 10 Watts, Power rating with convection cooling (W) , 5V-12VV in 0.1V increments, Approvals: RCM; EAC; CCC; CE; China RoHS; Double Insulation; Level VI; LPS; PSE; VCCI; WEEE; cULus; PSE;

### Model Picture



Agency Documents	<a href="http://www.globtek.info/certs/GT-86120-WWVV-W2Z/">http://www.globtek.info/certs/GT-86120-WWVV-W2Z/</a>
CE EC-Declaration	<a href="https://www.globtek.com/pdf/ec_declaration/a0Oa000000MmW10EAF">https://www.globtek.com/pdf/ec_declaration/a0Oa000000MmW10EAF</a>
RoHS/RoHS2 Declaration	<a href="https://www.globtek.com/pdf/rohs_cert/a0Oa000000MmW10EAF">https://www.globtek.com/pdf/rohs_cert/a0Oa000000MmW10EAF</a>
REACH Declaration	<a href="https://www.globtek.com/pdf/iso_certificates/REACH.pdf">https://www.globtek.com/pdf/iso_certificates/REACH.pdf</a>
Conflict Minerals Declaration	<a href="https://www.globtek.com/pdf/conflict-minerals.pdf">https://www.globtek.com/pdf/conflict-minerals.pdf</a>

Delivering leading edge, innovative power solutions for more than **30** years....

Model:GT-86120-WWVV (G-Blade)

April 10, 2020

**MODEL PARAMETERS**

Type	Wall Plug-in
Technology	Regulated Switchmode AC-DC Power Supply AC Adaptor
Category	ITE Power Supply
Input Voltage	100-240V~, 50-60Hz
I/P Amps (A)	0.5A
Wattage (W)	10.0
Vout Range (V)	5V-12V
Efficiency Level	USA DOE Level VI / Eco-design Directive 2009/125/EC, (EU) 2019/1782
Ingress Protection	IPX0
Size (mm)	70(L) *32.8(W) *48.5(H)

**PROPRIETARY INFORMATION**

PROPRIETARY OF GLOBTEK, INC. ANY REPRODUCTION, DISCLOSURE OR USE OF THIS DRAWING, IN WHOLE OR IN PART, IS HEREBY PROHIBITED EXCEPT AS SPECIFIED IN WRITING BY GLOBTEK, INC.

<http://en.globtek.com/datasheet/id/a0Oa000000MmW10>

Delivering leading edge, innovative power solutions for more than **30** years....

Model:GT-86120-WVVV (G-Blade)

April 10, 2020

# ENCLOSURE

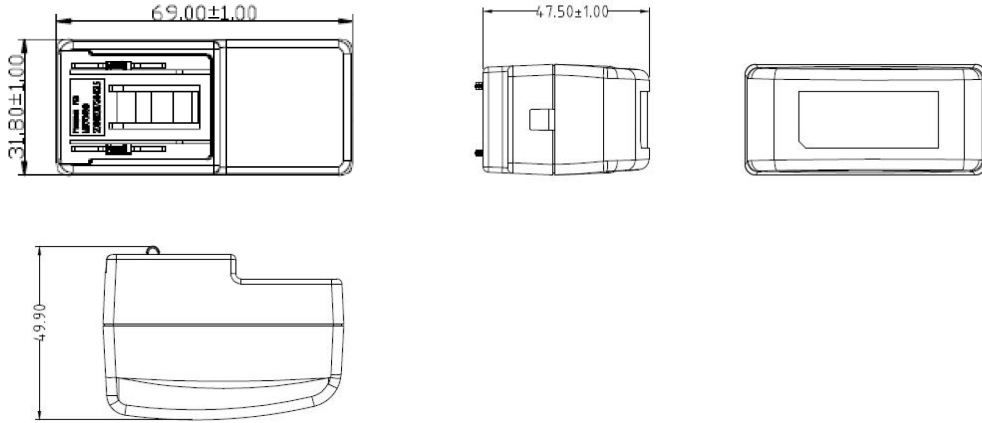

Delivering leading edge, innovative power solutions for more than **30** years....

Model:GT-86120-WWVV (G-Blade)

April 10, 2020

## RATING TABLE

Model Number	Voltage	Amps(A)	Watts(W)	RFQ
GT-86120-1005	5 V	2	10.00	<a href="#">RFQ</a>
GT-86120-1012-6.05	5.95 V	1.68	10.00	<a href="#">RFQ</a>
GT-86120-1012-3.0	9 V	1.11	9.99	<a href="#">RFQ</a>
GT-86120-1212	12 V	1	12.00	<a href="#">RFQ</a>

Model:GT-86120-WWVV (G-Blade)

April 10, 2020

## SPECIFICATIONS

### A) ELECTRICAL SPECIFICATIONS:

01. Input Voltage: Specified 90-264 Vac, Nameplate rated: 100-240Vac
02. Input Frequency: Specified 47-63 Hz, Nameplate rated 50-60Hz
03. Output Regulation: +/- 5%
04. Ripple and Noise (Vp-p): 200 mVp-p maximum, At 20 MHz, and output parallel with 0.1uF & 10uF capacitors to ground. Temperature at 25 °C, and nominal input voltage
05. Average Efficiency: 83.26% minimum, At 115VAC&230VAC input voltage, 1/4,2/4,3/4, and full load calculation average efficiency. adapter meet Efficiency level COC V5 Tier 1 and DOE VI
06. Turn-ON Delay: 3 Seconds maximum at nominal input voltage
07. Rise Time: 100mS maximum at nominal input voltage

### B) PROTECTION

01. Over-Voltage: 25VDC maximum
02. Over current protection: 2.5A maximum with auto-recovery function
03. Short Circuit: Short circuit protection is to be included in the construction of the adaptor. The adaptor is designed to withstand continuous current of a short circuit on the output. The adaptor will be short circuit tolerant for an indefinite period.

### C) SAFETY

01. Dielectric Withstand Voltage: 3000VAC 10mA 1minute or 4242VDC 10mA 1minute from primary to secondary
02. Leakage current: 0.25mA maximum, at nominal AC input voltage and frequency

### D) OTHER:

01. MTBF: 200,000 Hours @ 25°C ambient temperature
02. Operating Temperature: 0°C to 50°C ambient temperature (RFP7139)
03. Humidity: 0% to 90% relative humidity
04. Storage Temperature: -10°C to 80°C
05. Cooling: natural convection cooling
06. ROHS 2: Complies with EU 2011/65/EU and China SJ/T 11363-2006

### E) ENCLOSURE

01. Housing: High impact plastic, 94V0 polycarbonate, non-vented
02. Markings: Label and/or Pad Printed and/or Molded in the case

Delivering leading edge, innovative power solutions for more than **30** years....

Model:GT-86120-WWVV (G-Blade)

April 10, 2020

## DERATING CURVE

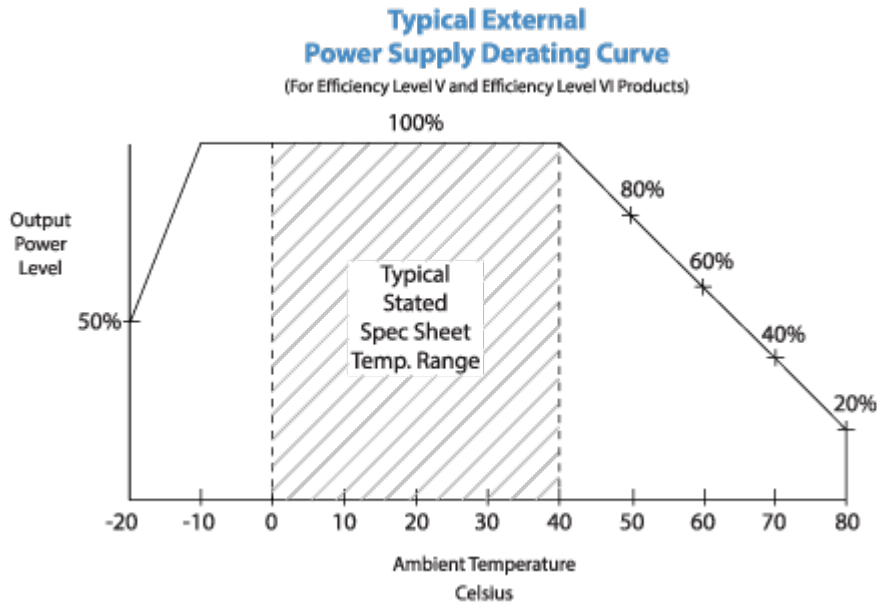

Delivering leading edge, innovative power solutions for more than 30 years....

Model:GT-86120-WWVV (G-Blade)

April 10, 2020

**INPUT CONFIGURATION**

Description

Blade Options for G- Series Wall Plug-in Power Supplies

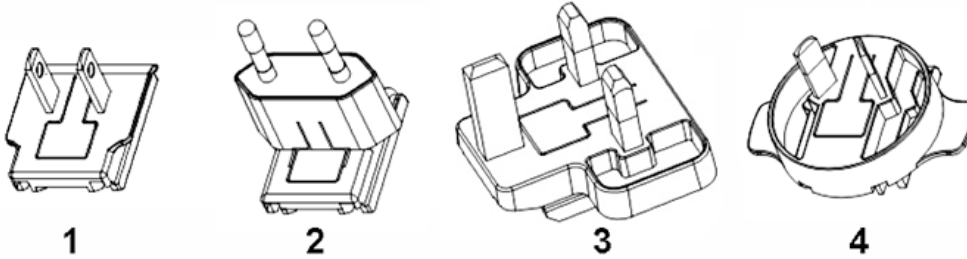

INPUT CONNECTOR: G-Socket (below are available blades configurations which are "not included" (unless stated above); can be purchased separately, package with power supply or as a separate "G-KIT" if specified

01. United States / Canada / Japan NEMA 1-15P configuration: NA 2 blades, Class II; US/CA/JP P/N: G-NA(R)
02. European CEE 7/16 configuration: Europlug 2 pins, Class II; EU P/N: G-EU(R)
03. UK BS 1363 configuration: UK 3 blade with dummy Ground, Class II; GB P/N: G-UK(R)
04. Australian AS 3112 configuration: SAA 2 blade, Class II; AU P/N: G-SAA(R)

Delivering leading edge, innovative power solutions for more than 30 years....

Model:GT-86120-WWVV (G-Blade)

April 10, 2020

**OUTPUT CONFIGURATION**

Common output connector options:

 L Type (Coaxial  
5.5x2.5mm plug)

 C Type (Coaxial  
5.5x2.1mm plug)

 K Type (Coaxial  
3.5x1.3mm plug)

 LL Type (5.5x2.5mm  
Locking 760k type)

 CL Type (5.5x2.1mm  
Locking S761k type)

 ML2 Type (Molex  
housing 43025-0200)

 YL3 Type  
(KPPX-3P)

YL4 Type (KPPX-4P)

 EJ1/2/3/4/5 (EIAJ  
RC-5320A type  
connectors)

 MSB Type (Micro  
USB)

 USBC Type (USB  
Type C)

 Inquire for custom  
design

 For a comprehensive list of options, [click here](#)

Contact GlobTek for your specific requirements or custom solutions.











Delivering leading edge, innovative power solutions for more than 30 years....

Model:GT-86120-WVVV (G-Blade)

April 10, 2020



## Approvals

Logo	Description
	Attention Mark / Refer to operating manual for operating and service instructions
 5000	CCC Altitude up to 5000 m GB17625.1-2012, GB4943.1-2011, GB/T9254-2008
	CE Mark: tested to comply with EN55022:2006/A1:2007 Class B, EN610003-2, EN610003-3 including EN61000-4-2, EN61000-4-3, EN61000-4-4, EN61000-4-5, EN61000-4-6N EN61000-4-11; EMI: Complies with EN55011 CLASS B and FCC Part 15B - On label or Molded in case
	CHINA SJ/T 11364-2014, China RoHS Chart: <a href="http://en.globtek.com/globtek-rohs.php">http://en.globtek.com/globtek-rohs.php</a>
	UL60950-1, cULus to UL 60950-1, 2nd Edition, 2007-03-27 and CSA C22.2 No. 60950-1-07, 2nd Edition, 2007-03 ( 5V and 12V)
	Declaration ДС № EAЭC N RU Д-US.KA01.B.10453_19 Custom Union of Russia, Belarus and Kazakhstan <a href="http://www.globtek.com/redirect/?loc=gost-certificate-eac-declaration">http://www.globtek.com/redirect/?loc=gost-certificate-eac-declaration</a>
	Indoor Use Only - Mark is on the label or Molded in the case
 GlobTek, Inc.	JAPAN TUV R-PSE, Cert. No. JD 50316221, to J60950-1(H26) , J55022(H22),[15V or less]. Please reference the following website for guidelines on PSE regulations: <a href="http://en.globtek.com/importing-ite-and-medical-power-supplies-ac-adaptors-to-japan/">http://en.globtek.com/importing-ite-and-medical-power-supplies-ac-adaptors-to-japan/</a>
	Efficiency: complies to section 301 of Energy Independence and Security Act (EISA) complies with Energy Star tier 2 (North America), ECP tier 2 (China), MEPS tier 2 (Australia), Code of Conduct (Europe)

Delivering leading edge, innovative power solutions for more than **30** years....

Model:GT-86120-WWVV (G-Blade)

April 10, 2020

LPS	Limited Power Source 60950
	Morocco SDoC declaration <a href="http://www.globtek.info/certs/Morocco%20SDoC%20Declaration/">http://www.globtek.info/certs/Morocco%20SDoC%20Declaration/</a>
 GlobTek, Inc.	JAPAN TUV Rheinland-PSE GlobTek Inc to J60950-1(H26) , J55022(H22),J3000(H25).Please follow the procedure listed in the following link for proper import to Japan: <a href="http://en.globtek.com/importing-to-japan.php">http://en.globtek.com/importing-to-japan.php</a> .
	RCM certificate SAA-171972-EA; Australia and New Zealand Regulatory Compliance, Mark ( <a href="http://rcm.standards.org.au/rcmfaq/rcmfaq.htm">http://rcm.standards.org.au/rcmfaq/rcmfaq.htm</a> )
	Japan: Voluntary Control Council for Interference (VCCI)
	WEEE: Complies with EU 2012/19/EU ( <a href="http://ec.europa.eu/environment/waste/weee/index_en.htm">http://ec.europa.eu/environment/waste/weee/index_en.htm</a> ) Mark is on the label or Molded in the case