

Delivering leading edge, innovative power solutions for more than **30** years....

Model:GT-46120-12VV-x.x-Q

April 1, 2020

DOE EPS 2.0 Level VI Power Supply / Charger / AC Adapter, 12W, Available with 5-24VDC output Certified to Medical and ITE Standards

Information

Model Number	GT-46120-12VV-x.x-Q
Description	GT-46120-12VV-x.x-Q, ITE Power Supply, Wall Plug-in, Regulated Switchmode AC-DC Power Supply AC Adaptor, , Input Rating: 100-240V~, 50-60 Hz, Blade Options for Q Series Wall Plug-in Power Supplies, Output Rating: 12 Watts, Power rating with convection cooling (W) , 5-48V in 0.1V increments, Approvals: 230V CoC Tier 2; EAC; CE; China RoHS; Double Insulation; Level VI; PSE; RoHS; Ukraine; VCCI; WEEE;
Model Picture	
Agency Documents	http://www.globtek.info/certs/GT-46120-WVVV/
CE EC-Declaration	https://www.globtek.com/pdf/ec_declaration/a0Oa000000Nrw14EAB
RoHS/RoHS2 Declaration	https://www.globtek.com/pdf/rohs_cert/a0Oa000000Nrw14EAB
REACH Declaration	https://www.globtek.com/pdf/iso_certificates/REACH.pdf
Conflict Minerals Declaration	https://www.globtek.com/pdf/conflict-minerals.pdf

Delivering leading edge, innovative power solutions for more than **30** years....

Model:GT-46120-12VV-x.x-Q

April 1, 2020

MODEL PARAMETERS

Type	Wall Plug-in
Technology	Regulated Switchmode AC-DC Power Supply AC Adaptor
Category	ITE Power Supply
Input Voltage	100-240V~, 50-60 Hz
I/P Amps (A)	0.6A
Wattage (W)	12.0
Vout Range (V)	5-48
Efficiency Level	USA DOE Level VI / Eco-design Directive 2009/125/EC, (EU) 2019/1782
Ingress Protection	IP52
Size (mm)	64.0*40.5*31.5

Delivering leading edge, innovative power solutions for more than 30 years....

Model:GT-46120-12VV-x.x-Q

April 1, 2020

ENCLOSURE

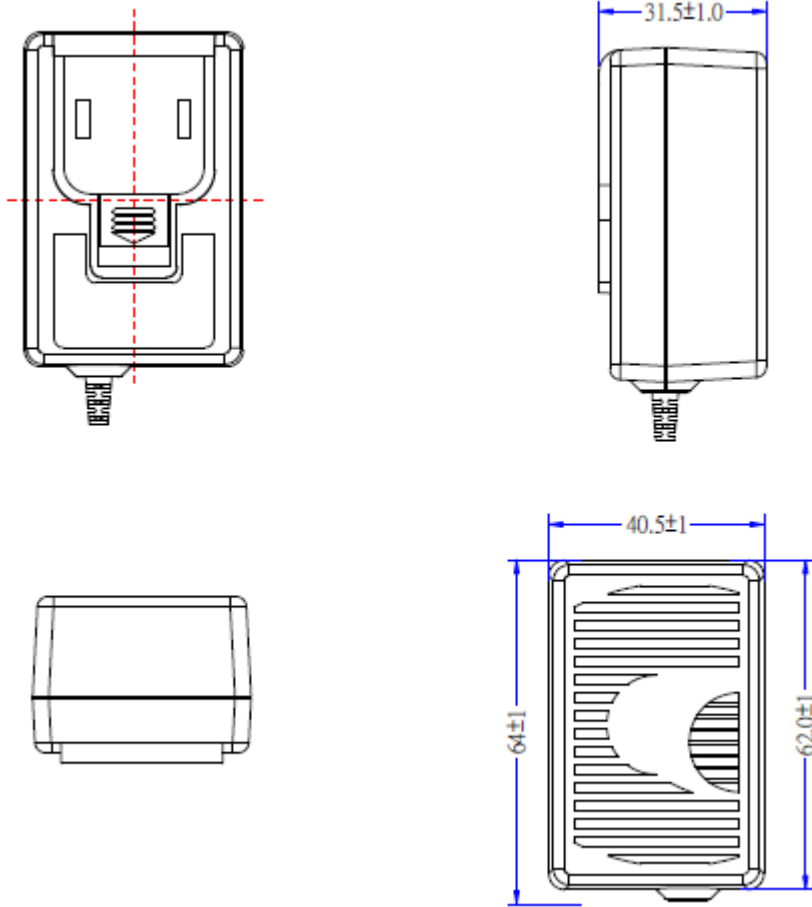

Delivering leading edge, innovative power solutions for more than **30** years....

Model:GT-46120-12VV-x.x-Q

April 1, 2020

RATING TABLE

Model Number	Voltage	Amps(A)	Watts(W)	RFQ
GT-46120-1005	5 V	2	10.00	RFQ
GT-46120-1206-0.05	5.95 V	2	11.90	RFQ
GT-46120-1212-4.5	7.5 V	1.33	9.98	RFQ
GT-46120-1212-3.0	9 V	1.33	11.97	RFQ
GT-46120-1212	12 V	1	12.00	RFQ
GT-46120-1224-9.0	15 V	0.8	12.00	RFQ
GT-46120-1215	15 V	0.8	12.00	RFQ
GT-46120-1224-4.0	20 V	0.6	12.00	RFQ
GT-46120-1224	24 V	0.5	12.00	RFQ
GT-46120-1248	48 V	0.25	12.00	RFQ

SPECIFICATIONS

A) ELECTRICAL SPECIFICATIONS:

01. Input Voltage: Specified 90-264 Vac, Nameplate rated: 100-240Vac
02. Input Frequency: Specified 47-63 Hz, Nameplate rated 50-60Hz
03. Output Regulation: +/- 5% measured at the output connector
04. Line Voltage Regulation: +/- 1% typical measured at the output connector
05. Average Efficiency: 82.96% Min (CEC & DOE LEVEL VI Compliant); 83.26% Min (ErP European Commission's Ecodesign Directive (2005/32/EC) / CoC Tier 2 Compliant)
06. Input Power(no load): <0.1W (CEC &DOE Level VI Compliant); <0.075W ErP European Commission's Ecodesign Directive (2005/32/EC) / CoC Tier 2 Compliant)
07. Output Ripple (Vp-p): +/-1% or 150 mV whichever is greater, measured at 20 MHz bandwidth with 0.1 uf ceramic capacitor in parallel with 10 uf electrolytic capacitor connected at the end of the output connector at nominal line
08. Turn-ON/OFF Overshoot: 5% maximum, 1 mS typical recovery time for 25% step load
09. Turn-ON Delay: 1 Sec,typical
10. Hold-Up Time: 8 mS typical at nominal input voltage and full load
11. Inrush Current: 30A typical at 115VAC input ; 60A typical at 230VAC input
12. Switching Frequency: 65 KHz typical

B) PROTECTION

01. Over-Voltage: Protected Zener clamp across the output
02. Short Circuit: Protected unit will auto recover upon removal of fault
03. Input Protection: Input line fusing

C) SAFETY

01. Dielectric Withstand Voltage: 4242Vdc from primary to secondary
02. Touch Current: <0.25mA @ 240Vac input voltage

D) EMC

01. Emissions, per EN 55032, EN 61000-6-3, EN 61000-6-4
 - Conducted Emissions: Class B, FCC Part 15, Class B
 - Radiated Emissions: Class B, FCC Part 15, Class B
02. Line Frequency Harmonics EN61000-3-2, Class A
03. Voltage Fluctuations/Flicker EN61000-3-3
04. Immunity, per EN 55024, EN 61000-6-1, EN 61000-6-2
 - Static Discharge Immunity EN61000-4-2, 4kV Contact Discharge, 8kV air discharge
 - Radiated RF Immunity EN61000-4-3, 3V/m 80-1000MHz, 80% 1KHz AM.
 - EFT/Burst Immunity EN61000-4-4, 1kV/100kHz.
 - Line Surge Immunity EN61000-4-5, 1kV differential, 2kV common-mode
 - Conducted RF Immunity EN61000-4-6, 3Vrms, 80% 1KHz AM
 - Power Frequency Magnetic Field Immunity EN61000-4-8, 1A/m
 - Voltage Dip Immunity EN61000-4-11, Criteria

E) OTHER:

01. MTBF: 200,000 Hours @ 25°C ambient temperature
02. Operating Temperature: 0°C to 40°C ambient temperature

PROPRIETARY INFORMATION

PROPRIETARY OF GLOBTEK, INC. ANY REPRODUCTION, DISCLOSURE OR USE OF THIS DRAWING, IN WHOLE OR IN PART, IS HEREBY PROHIBITED EXCEPT AS SPECIFIED IN WRITING BY GLOBTEK, INC.

<http://en.globtek.com/datasheet/id/a0Oa000000Nrw14>

Delivering leading edge, innovative power solutions for more than **30** years....

Model:GT-46120-12VV-x.x-Q

April 1, 2020

- 03. Humidity: 0% to 90% relative humidity
- 04. Storage Temperature: -10°C to 80°C
- 05. Cooling: Convection

F) ENCLOSURE

- 01. Housing: High impact plastic, 94V0 polycarbonate, non-vented
 - 02. Size: 64.0*40.5*31.5 +/-1.0 mm
 - 03. Markings: Label and/or Pad Printed and/or Molded in the case
-

Delivering leading edge, innovative power solutions for more than 30 years....

Model:GT-46120-12VV-x.x-Q

April 1, 2020

DERATING CURVE



Delivering leading edge, innovative power solutions for more than 30 years....

Model:GT-46120-12VV-x.x-Q

April 1, 2020

INPUT CONFIGURATION

Description Blade Options for Q Series Wall Plug-in Power Supplies

 Data Sheet: <http://en.globtek.com/interchangeable-blades.php>

 Insertion Instructions: <http://www.globtek.com/pdf/Instructions-Interchangeable-Blades.pdf>

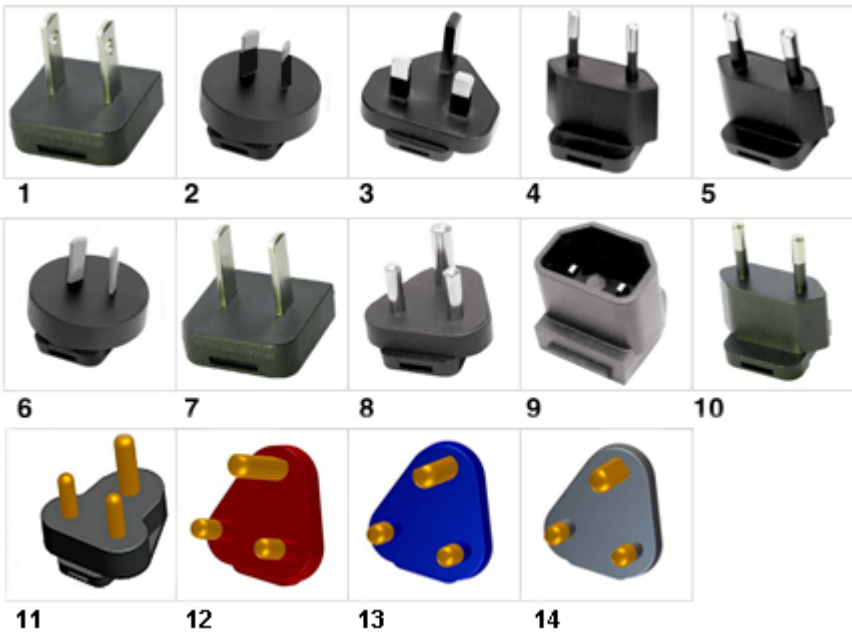
 Video: [Q-Blade Style Instruction Video](#)

INPUT CONNECTOR: Q-Socket (below are available blades configurations which are "not included" (unless stated above); can be purchased separately, package with power supply or as a separate "Q-KIT" if specified

01. United States / Canada / Japan NEMA 1-15P/IEC PLUG A[WORKS IN PLUG B] configuration: NA 2 blades, Class II; US/CA/JP P/N: Q-NA(R)
02. Australian AS 3112 configuration: SAA 2 blade/IEC TYPE I, Class II; AU P/N: Q-SAA(R)
03. UK BS 1363 configuration: UK 3 blade with dummy Ground/IEC TYPE G, Class II; GB P/N: Q-UK(R)
04. European CEE 7/16 configuration: Europlug 2 pins/IEC TYPE C [WORKS IN TYPE E&F], Class II; EU P/N: Q-EU(R)
05. Korean KS C8305 configuration: 2 pins/SIMILAR TO IEC TYPE C, Class II; KR P/N: Q-KR(R)
06. Argentina IRAM 2073 configuration: 2 blades/SIMILAR TO IEC TYPE I; AR P/N: Class II Q-AR(R)
07. China GB 2099 configuration: 2 blades/SIMILAR TO TYPE A, Class II; CN P/N:Q-CN(R)
08. India IS 1293 6A/BS546 configuration: 5A, 3 pins with Dummy Ground, Class II/IEC TYPE D; IN P/N: Q-IN(R)
09. IEC320/C18 Inlet, Class II; P/N: Q-C18(R)
10. Brazilian NBR6147 configuration: 2 pins, Class II;SIMILAR TO IEC TYPE C BR P/N: Q-BR(R)
11. South Africa SABS164-1, 3 round prongs, Class II + dummy ground, IEC TYPE M P/N: Q-SANS164-1-16A(R)
12. South Africa SABS164-4, 3 round prongs with a notched prong @ 0°, Class II + dummy ground, IEC TYPE M Red, P/N: Q-SANS164-4L-16A(R)
13. South Africa SABS164-4, 3 round prongs with a notched prong @ -53°, Class II + dummy ground, Blue, IEC TYPE M,

PROPRIETARY INFORMATION

PROPRIETARY OF GLOBTEK, INC. ANY REPRODUCTION, DISCLOSURE OR USE OF THIS DRAWING, IN WHOLE OR IN PART, IS HEREBY PROHIBITED EXCEPT AS SPECIFIED IN WRITING BY GLOBTEK, INC.

<http://en.globtek.com/datasheet/id/a0Oa000000Nrw14>

Delivering leading edge, innovative power solutions for more than **30** years....

Model:GT-46120-12VV-x.x-Q

April 1, 2020

P/N:
Q-SANS164-4C-16A(R)
14. South Africa SABS164-4, 3 round prongs with a notched prong @ +53°, Class II + dummy ground, Black,IEC TYPE M
P/N:
Q-SANS164-4R-16A(R)

Kits

01. Q-KIT: 1,2,3,4 above
02. Q-KIT-INTL: 2,3,4 above
03. Q-KIT-6: 1,2,3,4,5,6 above
04. Q-KIT-7: 1,2,3,4,5,6,7 above
05. Q-KIT-8: 1,2,3,4,5,6,7,8 above

Delivering leading edge, innovative power solutions for more than 30 years....

Model:GT-46120-12VV-x.x-Q

April 1, 2020

OUTPUT CONFIGURATION

Common output connector options:

 L Type (Coaxial
5.5x2.5mm plug)

 C Type (Coaxial
5.5x2.1mm plug)

 K Type (Coaxial
3.5x1.3mm plug)

 LL Type (5.5x2.5mm
Locking 760k type)

 CL Type (5.5x2.1mm
Locking S761k type)

 ML2 Type (Molex
housing 43025-0200)

 YL3 Type
(KPPX-3P)

YL4 Type (KPPX-4P)

 EJ1/2/3/4/5 (EIAJ
RC-5320A type
connectors)

 MSB Type (Micro
USB)

 USBC Type (USB
Type C)

 Inquire for custom
design

 For a comprehensive list of options, [click here](#)









Contact GlobTek for your specific requirements or custom solutions.

Delivering leading edge, innovative power solutions for more than 30 years....

Model:GT-46120-12VV-x.x-Q

April 1, 2020



Approvals

Logo	Description
No Logo Applicable	EU 230V CoC Tier 2, 278/2009, Mar 2014
	CE Certification
	CHINA SJ/T 11364-2014, China RoHS Chart: http://en.globtek.com/globtek-rohs.php
	Declaration ДС № EAЭC N RU Д-US.KA01.B.10453_19 Custom Union of Russia, Belarus and Kazakhstan http://www.globtek.com/redirect/?loc=gost-certificate-eac-declaration
	Indoor Use Only - Mark is on the label or Molded in the case
EFFICIENCY LEVEL 	Efficiency: complies to section 301 of Energy Independence and Security Act (EISA) complies with Energy Star tier 2 (North America), ECP tier 2 (China), MEPS tier 2 (Australia), Code of Conduct (Europe)
	Morocco SDoC declaration http://www.globtek.info/certs/Morocco%20SDoC%20Declaration/
 GlobTek, Inc.	JAPAN TUV Rheinland-PSE GlobTek Inc to J60950-1(H26) , J55022(H22),J3000(H25).Please follow the procedure listed in the following link for proper import to Japan: http://en.globtek.com/importing-to-japan.php .
RoHS	Specifications of directive 2011/65/EU Annex VI (ROHS-2) with amendment 2015/863-EU (ROHS-3) http://www.ce-mark.com/Rohs%20final.pdf
 10276	Ukraine UKR Sepro (Document: www.globtek.com/html/iso_certificates/GT_Ukraine.pdf)

Delivering leading edge, innovative power solutions for more than **30** years....

Model:GT-46120-12VV-x.x-Q

April 1, 2020

	Japan: Voluntary Control Council for Interference (VCCI)
	WEEE: Complies with EU 2012/19/EU (http://ec.europa.eu/environment/waste/weee/index_en.htm) Mark is on the label or Molded in the case