

Delivering leading edge, innovative power solutions for more than 30 years....

Model:GTM91120-30VV-F (PCB Mounted)

August 17, 2022

## GTM91120-30VV-F (PCB Mounted)

### Information

Model Number	GTM91120-30VV-F (PCB Mounted)
Description	GTM91120-30VV-F (PCB Mounted), Medical Power Supply, 60601-1-4th Ed. , Open Frame/Internal, Regulated Switchmode AC-DC Power Supply AC Adaptor, , Input Rating: 100-240V~, 50-60 Hz, Solder Pins for Line,Neutral and Ground, 1.4 mm square pins, 4.5 mm long, Output Rating: 30 Watts, Power rating with convection cooling (W) , 5-48V in 0.1V increments, Approvals: UKCA; ETL 62368; LPS 62368; CE; ETL; CB 60335; VCCI; CB 60601-1; CB 60950; CE; CE; China RoHS; FCC; GOST-R; Level V; RoHS; SIQ; Designed to meet EN 60601-1; SIQ; Ukraine; WEEE; cRUus; IEC/EN60601-1; IEC/EN60950-1; IEC 60335; UL/cUL; CB EN/IEC 60335-1; RCM;

### Model Picture

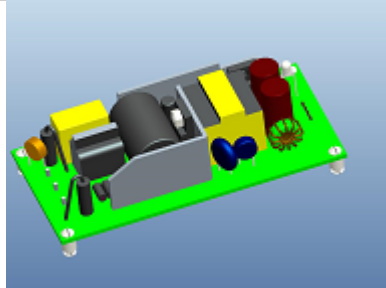

Agency Documents	<a href="http://www.globtek.info/certs/GTM91120-T2%20-T3A%20-FW/">http://www.globtek.info/certs/GTM91120-T2%20-T3A%20-FW/</a>
CE EC-Declaration	<a href="https://www.globtek.com/pdf/ec_declaration/a00a000000J7wUEAT">https://www.globtek.com/pdf/ec_declaration/a00a000000J7wUEAT</a>
RoHS/RoHS2 Declaration	<a href="https://www.globtek.com/pdf/rohs_cert/a00a000000J7wUEAT">https://www.globtek.com/pdf/rohs_cert/a00a000000J7wUEAT</a>
REACH Declaration	<a href="https://www.globtek.com/pdf/iso_certificates/REACH.pdf">https://www.globtek.com/pdf/iso_certificates/REACH.pdf</a>
Conflict Minerals Declaration	<a href="https://www.globtek.com/pdf/conflict-minerals.pdf">https://www.globtek.com/pdf/conflict-minerals.pdf</a>

Delivering leading edge, innovative power solutions for more than **30** years....

Model:GTM91120-30VV-F (PCB Mounted)

August 17, 2022

**MODEL PARAMETERS**

Type	Open Frame/Internal
Technology	Regulated Switchmode AC-DC Power Supply AC Adaptor
Category	Medical Power Supply
Input Voltage	100-240V~, 50-60 Hz
I/P Amps (A)	1.5A
Wattage (W)	30.0
Vout Range (V)	5-48
Efficiency Level	V
Ingress Protection	
Size (mm)	101.6x50.8x22.30

Delivering leading edge, innovative power solutions for more than 30 years....

Model:GTM91120-30VV-F (PCB Mounted)

August 17, 2022

ENCLOSURE

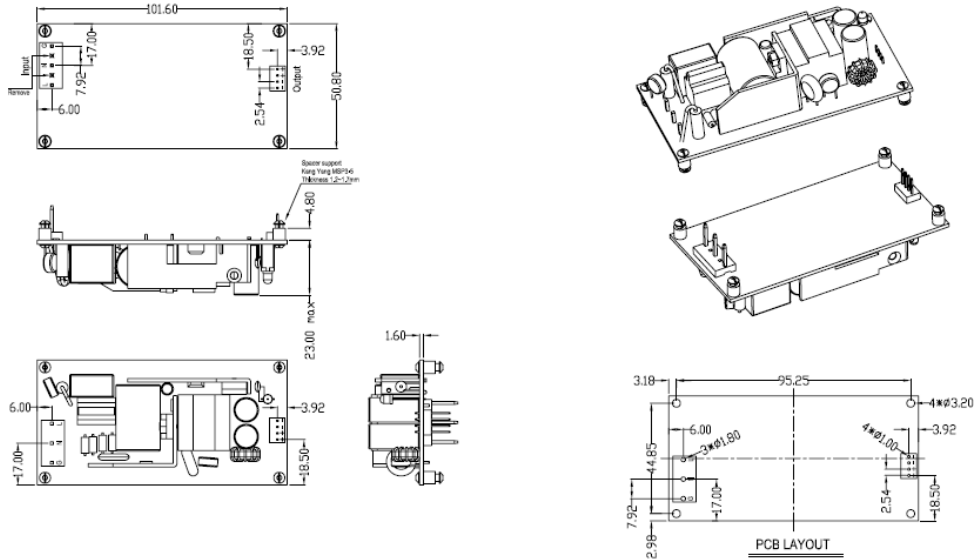

Delivering leading edge, innovative power solutions for more than **30** years....

Model:GTM91120-30VV-F (PCB Mounted)

August 17, 2022

**RATING TABLE**

Model Number	Voltage	Amps(A)	Watts(W)	RFQ
GTM91120-3012-FW (PCB Mounted)	12 V	2.5	30.00	<a href="#">RFQ</a>
GTM91120-3024-FW (PCB Mounted)	24 V	1.25	30.00	<a href="#">RFQ</a>

Model:GTM91120-30VV-F (PCB Mounted)

August 17, 2022

## SPECIFICATIONS

### A) ELECTRICAL SPECIFICATIONS:

1. Input Voltage: 100-240 Vac
2. Input Current: 1.5 A RMS max
3. Input Frequency: 47 - 63 Hz
4. Output power (rated): 30Watts max

Note: Refer to Power Supply information on page 2 for the corresponding rated output power for the specific output voltage.

5. Output Regulation: +/- 5% measured at the output connector
6. Line Voltage Regulation: +/- 2% typical measured at full load
7. Output Ripple (Vp-p): +/-2% maximum, measured at 20 MHz bandwidth with 0.1 uf ceramic capacitor in parallel with 10 uf electrolytic capacitor connected at the end of the output connector at nominal line  
Optional low ripple option available (RFP4579)
8. Turn-ON/OFF Overshoot: 5% maximum, 500uS typical recovery time for 25% to 50% step load
9. Turn-ON Delay: 3 Seconds, maximum @ full load, nominal line
10. Hold-Up Time: 8mS typical @ nominal input voltage and full load
11. Inrush Current: 60A maximum cold start @ 240Vac input
12. Switching Frequency: 100 KHz typical

### B) PROTECTION

1. Over-Voltage: Protected with a Zener diode clamp across the output
2. Short Circuit: Hiccup with auto recovery
3. Over-load: Hiccup with auto recovery
4. Input Protection: Input line and neutral fusing

### C) SAFETY

1. Dielectric Withstand Voltage: 5656Vdc from primary to secondary
2. Earth Leakage Current: <100 uA at 240Vac input voltage
3. MTBF: 200,000 hours @ 25°C ambient temperature
4. Operating Temperature: 0°C to 40°C ambient temperature

### D) OTHER:

1. MTBF: 200,000 Hours @ 25°C ambient temperature
2. Humidity: 0% to 90% relative humidity
3. Storage Temperature: -10°C to 80°C
4. Cooling: Convection

Delivering leading edge, innovative power solutions for more than **30** years....

Model:GTM91120-30VV-F (PCB Mounted)

August 17, 2022

## DERATING CURVE

---

Delivering leading edge, innovative power solutions for more than **30** years....

Model:GTM91120-30VV-F (PCB Mounted)

August 17, 2022

**INPUT CONFIGURATION**







Description	Solder Pins for Line,Neutral and Ground, 1.4 mm square pins, 4.5 mm long
-------------	--

Delivering leading edge, innovative power solutions for more than 30 years....

Model:GTM91120-30VV-F (PCB Mounted)

August 17, 2022

## Approvals









Logo	Description
	Attention Mark / Refer to operating manual for operating and service instructions
No Logo Applicable	CB report IEC 60601-1: 2005 + CORR. 1 (2006) + CORR. 2 (2007) and or EN 60601-1:2006 3rd Edition including 2MOOP requirements
No Logo	CB Certificate IEC 60950-1:2005 (2nd Edition), Am 1: 2009, CB report IEC 60950-1:2005 (2nd Edition), Am 1: 2009 and EN 60950-1:2006 + Am 1:2010 + Am 11:2009 + Am 12:2011
No Logo Applicable	CB to 60335-1 5th Edition (Safety of Household and Similar Electrical Appliances, Part 1: General Requirements) CB Report/ Certificate IEC 60335-1:2010 Up to 36 volts only
No Logo Applicable	IEC 60335-1:2010 (Fifth Edition) incl. Corr. 1:2010 and Corr. 2:2011 + A1:2013
	CE Mark: tested to comply with EN 55032:2012+AC:2013, EN 61000-3-2:2014, EN 61000-3-3:2013, EN 55024:2010, EN 60601-1-2:2015
	CE Mark: tested to comply with EN55022:2006/A1:2007 Class B, EN610003-2, EN610003-3 including EN61000-4-2, EN61000-4-3, EN61000-4-4, EN61000-4-5, EN61000-4-6N EN61000-4-11; EMI: Complies with EN55011 CLASS B and FCC Part 15B - On label or Molded in case
	CE Mark: tested to comply with EN 60601-1-2:2015 Medical electrical equipment Part 1-2: - Mark is on the label or Molded in the case
	Audio/Video, Information And Communication Technology Equipment - Part 1: Safety Requirements [UL 62368-1:2014 Ed.2] Audio/Video, Information And Communication Technology Equipment - Part 1: Safety Requirements [CSA C22.2#62368-1:2014 Ed.2]
	AAMI ES60601-1:2005 +A1 - Medical Electrical Equipment - Part 1: General Requirements CAN/CSA-C22.2 No.60601-1:14, Third Edition Issued: 2014/03/01 - Medical Electrical Equipment - Part 1 IEC 60601-1-11 Issued: 2015/01/20 Ed. 2 Medical Elec. Equip.



Delivering leading edge, innovative power solutions for more than 30 years....

Model:GTM91120-30VV-F (PCB Mounted)







August 17, 2022

	CHINA SJ/T 11364-2014, China RoHS Chart: <a href="http://en.globtek.com/globtek-rohs.php">http://en.globtek.com/globtek-rohs.php</a>
	cRUus UL Recognized Component E341350 3rd Edition w-RM ANSI-AAMI ES60601-1 (2005 + C1:09 + A2:10) and CAN-CSA-C22.2 No. 60601-1 (2008)
	UL60950-1, cULus to UL 60950-1, 2nd Edition, 2007-03-27 and CSA C22.2 No. 60950-1-07, 2nd Edition, 2007-03
No Logo	Designed to meet EN 60601-1:2006 + A11:2011 +A1:2013 3rd Edition
	FCC PART 15 CLASS B
	GOST-R mark for Russia(Document: <a href="http://www.globtek.com/html/iso_certificates/GT_GOST-R.pdf">http://www.globtek.com/html/iso_certificates/GT_GOST-R.pdf</a> ). 03/15/2015. Due to lack of demand, GlobTek will not be renewing it's GOST certification. Please contact your sales engineer for pricing on EAC.
<b>IEC/EN60335-1</b>	IEC/EN60335-1 Up to 36 volts
<b>IEC/EN60601-1</b>	IEC/EN60601-1
<b>IEC/EN60950-1</b>	IEC/EN60950-1
	Indoor Use Only - Mark is on the label or Molded in the case
<b>EFFICIENCY LEVEL</b> 	Efficiency: complies to section 301 of Energy Independence and Security Act (EISA) complies with Energy Star tier 2 (North America), ECP tier 2 (China), MEPS tier 2 (Australia), Code of Conduct (Europe)
LPS	Limited Power Source 62368
	RCM certificate SAA150575; Australia and New Zealand Regulatory Compliance, Mark ( <a href="http://rcm.standards.org.au/rcmfaq/rcmfaq.htm">http://rcm.standards.org.au/rcmfaq/rcmfaq.htm</a> )
RoHS	Specifications of directive 2011/65/EU Annex VI (ROHS-2) with amendment 2015/863-EU (ROHS-3) <a href="http://www.ce-mark.com/Rohs%20final.pdf">http://www.ce-mark.com/Rohs%20final.pdf</a>

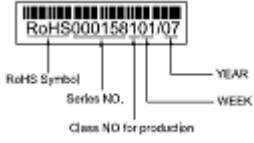
Delivering leading edge, innovative power solutions for more than **30** years....

Model:GTM91120-30VV-F (PCB Mounted)

August 17, 2022

	Serial Number Information
 IEC/EN60335-1	SIQ IEC/EN 60335-1 (Safety of Household and Similar Electrical Appliances, Part 1: General Requirements) up to 36 volts
 IEC/EN60601-1	SIQ Mark License EN60601-1, 3rd edition
	UKCA Certification
 10276	Ukraine UKRSePro (Document: <a href="http://www.globtek.com/html/iso_certificates/GT_Ukraine.pdf">www.globtek.com/html/iso_certificates/GT_Ukraine.pdf</a> )
	Japan: Voluntary Control Council for Interference (VCCI)
	WEEE: Complies with EU 2012/19/EU ( <a href="http://ec.europa.eu/environment/waste/weee/index_en.htm">http://ec.europa.eu/environment/waste/weee/index_en.htm</a> ) Mark is on the label or Molded in the case