

Delivering leading edge, innovative power solutions for more than 30 years....

Model:GTM96600-65VV.V-P2

October 7, 2022

65w Constant Voltage Power Supply/LED Driver

Information

Model Number

GTM96600-65VV.V-P2

Description

GTM96600-65VV.V-P2, ICT / ITE / Medical Power Supply/Class 2/Household Power Supply, 60601-1-4th Ed. , Potted/Encapsulated in plastic housing, Regulated Switchmode AC-DC Power Supply AC Adaptor, , Input Rating: 100-240V~, 50-60Hz, See "Blade/Cord Installed" section. Contact GlobTek for customization requests such as Molded country plugs, Molex or TE connectors, or IEC connectors mounted on any type of cable in any customer specified lengths., Output Rating: 65 Watts, Power rating with convection cooling (W) , 5-54V in 0.1V increments, Approvals: cETLus 60601-1; IP68; CB 60950; CE; China RoHS; Double Insulation; PSE; PSE; PSE; Level VI; Ukraine; VCCI; WEEE; LPS 60950; RCM; CB 62368; EAC; cETLus UL1310 (36V only); S-Mark IEC/EN 60601-1; UL 1310; CB 61158; Morocco; FCC; UKCA;

Model Picture



Agency Documents

<http://www.globtek.info/certs/GTM96600-TZ/>

CE EC-Declaration

https://www.globtek.com/pdf/ec_declaration/a00a000000PRtgwEAD

RoHS/RoHS2 Declaration

https://www.globtek.com/pdf/rohs_cert/a00a000000PRtgwEAD

REACH Declaration

https://www.globtek.com/pdf/iso_certificates/REACH.pdf

Conflict Minerals Declaration

<https://www.globtek.com/pdf/conflict-minerals.pdf>

Delivering leading edge, innovative power solutions for more than **30** years....

Model:GTM96600-65VV.V-P2

October 7, 2022

MODEL PARAMETERS

Type	Potted/Encapsulated in plastic housing
Technology	Regulated Switchmode AC-DC Power Supply AC Adaptor
Category	ICT / ITE / Medical Power Supply/Class 2/Household Power Supply
Input Voltage	100-240V~, 50-60Hz
I/P Amps (A)	1.5A
Wattage (W)	65.0
Vout Range (V)	5-54
Efficiency Level	USA DOE Level VI / Eco-design Directive 2009/125/EC, (EU) 2019/1782
Ingress Protection	IP68
Size (mm)	114.81*57.11*39.00

Delivering leading edge, innovative power solutions for more than 30 years....

Model:GTM96600-65VV.V-P2

October 7, 2022

ENCLOSURE

Ruggedized and waterproof IP68 construction

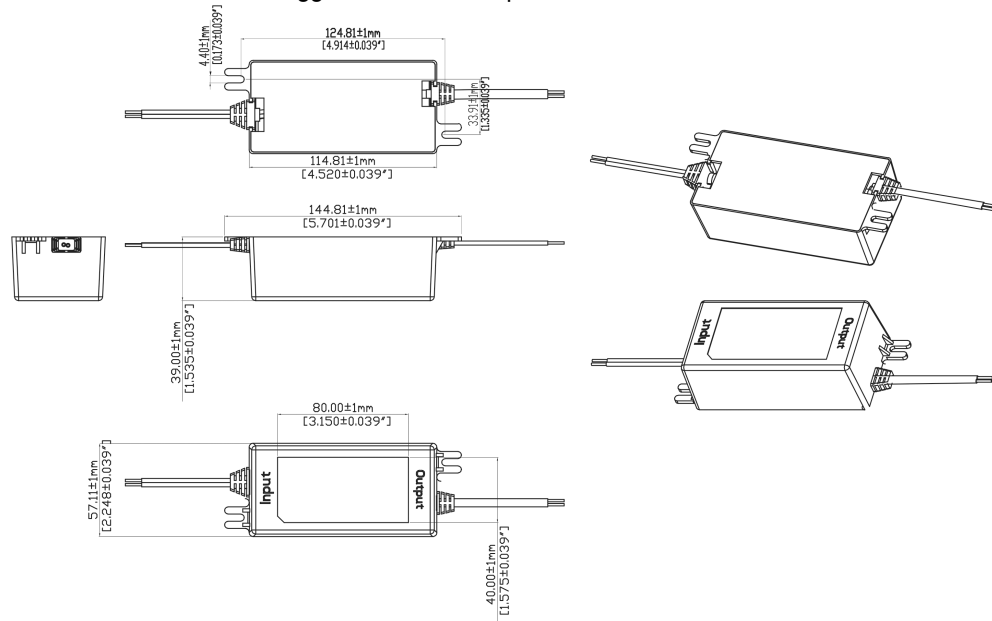

Input Blue wire is Neutral and Brown is Line (hot)

Delivering leading edge, innovative power solutions for more than **30** years....

Model:GTM96600-65VV.V-P2

October 7, 2022

RATING TABLE

Model Number	Voltage	Amps(A)	Watts(W)	RFQ
GTM96600-4005-P2	5 V	8	40.00	RFQ
GTM96600-5409-P2	9 V	6	54.00	RFQ
GTM96600-6512-P2	12 V	5.41	64.92	RFQ
GTM96600-6513.2-P2	13.2 V	4.92	64.94	RFQ
GTM96600-6515-P2	15 V	4.33	64.95	RFQ
GTM96600-6520-P2	20 V	3.25	65.00	RFQ
GTM96600-6524-P2	24 V	2.7	64.80	RFQ
GTM96600-6530-P2	30 V	2.16	64.80	RFQ
GTM96600-6536-P2	36 V	1.8	64.80	RFQ
GTM96600-6542-P2	42 V	1.54	64.68	RFQ
GTM96600-6548-P2	48 V	1.35	64.80	RFQ
GTM96600-6554-P2	54 V	1.2	64.80	RFQ

Delivering leading edge, innovative power solutions for more than 30 years....

Model:GTM96600-65VV.V-P2

October 7, 2022

SPECIFICATIONS

Input

Input Voltage:	Specified: 90-264VAC, Nameplate: 100-240VAC 100% rated load current for 90-264VAC 85% rated load current for 85-264VAC 100% rated load current for 110-370VDC
Input Frequency:	Specified: 47-63Hz, Nameplate: 50-60Hz
No Load Input Power:	<75mW @ 230VAC (EU CoC Tier 2 compliant) for ≤ 49W rating <150mW @ 230VAC (EU CoC Tier 2 compliant) for > 49W rating
Inrush Current:	30A/60A max. (cold start @ 115V/230VAC)
Efficiency:	DoE Level VI and EU CoC Tier 2 compliant

Output

Turn-on Delay:	1 second max. @ 115VAC and full load
Output Regulation:	± 5% (measured at output connector)
Line Regulation:	± 0.5% typ. (measured at output connector)
Ripple:	1% or 100mV, whichever is greater (using a 47µF low-ESR cap + 0.1µF ceramic capacitor, measured @ 20MHz BW, at output connector)
Transient Response:	5% max. deviation, 1ms typ. recovery time (with 40% to 70% load step)
Hold-up Time:	8ms typ. (nominal input voltage and full load)
Power Indicator:	Green LED

Protections

Input Protection:	MOV transient suppressor, input line fusing
Over-Current Protection:	110 - 160% of rated output current, auto-restart, current limit range determined by normal output power rating, not de-rated power rating
Short-Circuit Protection:	Auto-restart
Over-Voltage Protection:	110 - 130%, latched off, cycle AC to reset
Over-Temperature Protection:	On-chip temperature sensor (integrated in primary-side switching controller), shut down at T _j = ~140°C, latched off, cycle AC to reset

Environmental

MTBF:	1,500,000 hours @ 25°C ambient, full load (Telcordia SR-332, Issue 3)
Operating Temperature:	-20°C to 40°C (full load)
Storage Temperature:	-30°C to 80°C
Humidity:	0% to 95% relative humidity, non-condensing
Altitude:	5000m

Delivering leading edge, innovative power solutions for more than 30 years....

Model:GTM96600-65VV.V-P2

October 7, 2022

Cooling:	Convection
RoHS:	Complies with EU 2011/65/EU and China SJ/T 11363-2006
Note 1:	Regarding operating temperature a. See below de-rating table for output power capability at alternate temperature b. Extended low-end temperature range available as a custom option

Safety

Dielectric Withstand Voltage:	4000VAC or 5656VDC from input to output 3000VAC or 4242VDC from input to earth (Class I models only)
Touch Current:	Class I: 20 μ A max. Class II: 85 μ A max. Class II F2: 20 μ A max.
Earth Leakage Current	Class I: 300 μ A max. Class II: N/A
Means of Protection:	2 x MOPP
Output Isolation Options:	Class I: C6 or C14 inlet (output negative tied to Earth contact) Class II: C8 or C18 inlet Class II FE: C6 or C14 inlet (output isolated from Earth contact) Review isolation options by reading our white paper PSU Isolation and Identity .
Earth Continuity Test:	< 0.1 Ω between earth pin (on AC inlet) and PCB termination point (Class I models only)
Compliant Standards:	See listing at end of this datasheet for specific standards

EMC

Applicable Standards:	Medical: EN60601-1-2, 4th edition Emissions: EN55032, EN61000-6-3, EN61000-6-4, CISPR11, CISPR22 Immunity: EN55024, EN61000-6-1, EN61000-6-2
Conducted Emissions:	Class B, FCC Part 15, Class B (with resistive load)
Radiated Emissions:	Class B, FCC Part 15, Class B (with resistive load)
Harmonic Current Voltage Distortion:	EN61000-3-2, Class A
Voltage Fluctuations/Flicker:	EN61000-3-3
Electrostatic Discharge (ESD) Immunity:	EN61000-4-2, 10KV contact discharge, 20KV air discharge
Radiated RF Immunity:	EN61000-4-3, 10V/m 80-1000MHz, 3V/m 1-2.7GHz, 80% 1KHz AM
EFT/Burst Immunity:	EN61000-4-4, 4KV/100kHz.
Line Surge Immunity:	EN61000-4-5, 2KV differential, 4KV common-mode
Conducted RF Immunity:	EN61000-4-6, 3VRMS, 80% 1KHz AM
Power Frequency Magnetic Field Immunity:	EN61000-4-8, 3A/m
Voltage Dip Immunity:	EN61000-4-11

Enclosure

Housing:	High impact plastic, 94V0 polycarbonate, non-vented Desktop: C6, C7, C14, or C18 inlet
----------	---

Delivering leading edge, innovative power solutions for more than 30 years....

Model:GTM96600-65VV.V-P2

October 7, 2022

AC Input Mechanical Options:	Hybrid: Desktop inlet or changeable blades for wall-plug-in style, Class I or Class II input
Markings:	Label and/or pad printed and/or laser-etched into case

Special Options

1. Removal of LED (cost reduction or aesthetic purpose)
2. Custom cordsets, various cordage types, and connector types
3. Custom markings
4. Short term output surge capability for motors or other high peak current loads. (Available up to 120W for 1 second at nameplate voltage range. Higher levels possible for limited input voltage range, or larger allowed voltage dip.)
5. Reduced leakage current
6. Tightened output voltage tolerance
7. Reduced output ripple level
8. Reduced output power rating
9. High reliability PCB laminate with plated through-holes for IPC610 Class 2 compliance
10. Low temperature option, down to -40°C
11. Special housing and cordset colors
12. "Back EMF" upgrade, for motor loads and other high inductance applications with reverse energy flow requirements
13. Improved ingress protection (IP) rating

Output Connectors

- Several output connector options are available with various output current ratings. GlobTek can supply 10A rated 2.1mm and 2.5mm style DC Power Jacks, to complement our 10A output rated 2.1mm and 2.5mm DC power plugs used on our output cordsets.
- Please visit our real-time listing of mating connector product offering:
<https://en.globtek.com/news/high-current-coaxial-barrel-plug-jacks-for-high-wattage-power-supplies>

Delivering leading edge, innovative power solutions for more than 30 years....

Model:GTM96600-65VV.V-P2

October 7, 2022

DERATING CURVE



Delivering leading edge, innovative power solutions for more than **30** years....

Model:GTM96600-65VV.V-P2

October 7, 2022

INPUT CONFIGURATIONDescription

See "Blade/Cord Installed" section. Contact GlobTek for customization requests such as Molded country plugs, Molex or TE connectors, or IEC connectors mounted on any type of cable in any customer specified lengths.

Delivering leading edge, innovative power solutions for more than 30 years....

Model:GTM96600-65VV.V-P2

October 7, 2022

OUTPUT CONFIGURATION

Common output connector options:

 L Type (Coaxial
5.5x2.5mm plug)

 C Type (Coaxial
5.5x2.1mm plug)

 K Type (Coaxial
3.5x1.3mm plug)

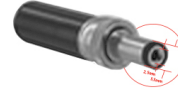
 LL Type (5.5x2.5mm
Locking 760k type)

 CL Type (5.5x2.1mm
Locking S761k type)

 ML2 Type (Molex
housing 43025-0200)

 YL3 Type
(KPPX-3P)

YL4 Type (KPPX-4P)

 EJ1/2/3/4/5 (EIAJ
RC-5320A type
connectors)

 MSB Type (Micro
USB)

 USBC Type (USB
Type C)

 Inquire for custom
design

 For a comprehensive list of options, [click here](#)







Contact GlobTek for your specific requirements or custom solutions.

Delivering leading edge, innovative power solutions for more than **30** years....

Model:GTM96600-65VV.V-P2

October 7, 2022









Approvals

Logo	Description
No Logo Applicable	CB for IEC 60950-1:2005+A1+A2
No Logo Applicable	IEC 61558-1:2005+A1, IEC 61558-2-16:2009+A1
No Logo Applicable	CB for IEC 62368-1:2014 (Second Edition)
	Test standard: EN 55032:2012+AC:2013 EN 61000-3-2:2014 EN 61000-3-3:2013 EN 55024:2010 EN 60601-1-2:2015
	Conforms to UL Std. 1310 CLASS 2 Power Units Cert. to CSA Std. C22.2 NO. 223 (36 volts only)
	CHINA SJ/T 11364-2014, China RoHS Chart: http://en.globtek.com/globtek-rohs.php
	
	Declaration ДС № EAЭC N RU Д-US.KA01.B.10453_19 Custom Union of Russia, Belarus and Kazakhstan http://www.globtek.com/redirect/?loc=gost-certificate-eac-declaration
	Medical Electrical Equipment - Part 1: General Requirements For Basic Safety And Essential Performance [AAMI ES60601-1:2005 +A1]
	Compliance of this power supply with FCC Part 15, Class B has been demonstrated with a standard output load. The FCC law stipulates that system-level testing is

Delivering leading edge, innovative power solutions for more than 30 years....

Model:GTM96600-65VV.V-P2



October 7, 2022

	required to demonstrate compliance with the FCC emission limits with the actual system load.
IP68	Ingress Protection: ?IP68 to IEC60529:2001 Totally dust tight and Protected against long periods of immersion under pressure
 GlobTek, Inc.	JAPAN TUV R-PSE, Cert. No. JD 50313287, to J60950-1(H26) , J55022(H22),J3000(H25)[DC15?30V]. Please reference the following website for guidelines on PSE regulations: http://en.globtek.com/importing-ite-and-medical-power-supplies-ac-adaptors-to-japan/
 GlobTek, Inc.	JAPAN TUV R-PSE, Cert. No. JD 50313287, to J60950-1(H26) , J55022(H22),J3000(H25)[DC30?60V]. Please reference the following website for guidelines on PSE regulations: http://en.globtek.com/importing-ite-and-medical-power-supplies-ac-adaptors-to-japan/
 GlobTek, Inc.	JAPAN TUV R-PSE, Cert. No. JD 50469658, to J62368-1(H30) , J55032(H29),J3000(H25)[15V or less]. Please reference the following website for guidelines on PSE regulations: http://en.globtek.com/importing-ite-and-medical-power-supplies-ac-adaptors-to-japan/
EFFICIENCY LEVEL 	Efficiency: complies to section 301 of Energy Independence and Security Act (EISA) complies with Energy Star tier 2 (North America), ECP tier 2 (China), MEPS tier 2 (Australia), Code of Conduct (Europe)
LPS	Limited Power Source 60950
	Morocco SDoC declaration http://www.globtek.info/certs/Morocco%20SDoC%20Declaration/
	RCM certificate ; Australia and New Zealand Regulatory Compliance, Mark (http://rcm.standards.org.au/rcmfaq/rcmfaq.htm
	S-Mark Certificate EN 60601-1:2006+A1+A12, EN 60601-1-11:2015
	UKCA Certification

Delivering leading edge, innovative power solutions for more than **30** years....

Model:GTM96600-65VV.V-P2

October 7, 2022

 10276	Ukraine UKRSepr (Document: www.globtek.com/html/iso_certificates/GT_Ukraine.pdf)
DO NOT REMOVE THE TAG WARNING/ADVERTISEMENT RISK OF ELECTRIC SHOCK DRY LOCATION USE ONLY FOR INDOOR USE ONLY Risque de choc électrique Utilisation endroit sec Pour une utilisation en intérieur See instructions if the input plug does not fit the power outlet	UL1310 Warning Label Up To 36 Volts with plugs
	Japan: Voluntary Control Council for Interference (VCCI)
	WEEE: Complies with EU 2012/19/EU (http://ec.europa.eu/environment/waste/weee/index_en.htm) Mark is on the label or Molded in the case